

Simply a question of
better measurement



SCHMIDT® LED Measured Value Display
MD 10.015
Instructions for Use

SCHMIDT® LED Measured Value Display

MD 10.015

Table of Contents

1	Important Information	3
2	Application range	4
3	Mounting instructions.....	4
4	Electrical connection.....	6
5	Operating modes	8
6	Signalizations	9
7	Startup	10
8	Configuration menu	18
9	Service information.....	24
10	Technical data	25
11	Declarations of conformity.....	26

Imprint:

Copyright 2022 **SCHMIDT Technology GmbH**

All rights reserved

Version: 531011.02D

Subject to modifications

1 Important Information

These instructions for use contain all required information for a fast commissioning and a safe operation of **SCHMIDT®** LED measured value displays:

- These instructions for use must be read completely and observed carefully, before putting the unit into operation.
- Any claims under the manufacturer's liability for damage resulting from non-observance or non-compliance with these instructions will become void.
- Tampering with the device in any way whatsoever - with the exception of the designated use and the operations described in these instructions for use - will forfeit any warranty and exclude any liability.
- The unit is designed exclusively for the use described below (refer to *chapter 2*). In particular, it is not designed for direct or indirect protection of personal or machinery.
- **SCHMIDT Technology** cannot give any warranty as to its suitability for certain purpose and cannot be held liable for accidental or sequential damage in connection with the delivery, performance or use of this unit.

Symbols used in this manual

The symbols used in this manual are explained in the following section.



Danger warnings and safety instructions. Read carefully!

Non-observance of these instructions may lead to injury of personal or malfunction of the device.



High voltage hazard – risk of life.



ESD susceptible elements (electrostatic discharge).

General note

All dimensions are indicated in mm.

2 Application range

The **SCHMIDT® LED Measured Value Display MD 10.015** (article no.: 527330 and 528250) is used to display measured values which are transmitted by up to two sensors via an analog signal (current or voltage).

The supply voltage of the sensors can be obtained from the LED display. The sum function is used to determine the flow volume. In bidirectional mode, a bidirectional flow signal can be generated from two unidirectional flow sensors. Switching points for two alarm outputs can be derived from the input signals and the quantity. The galvanically isolated analog output allows the scalable output of the display values.

The **SCHMIDT® LED Measured Value Display MD 10.015** can be used for **SCHMIDT®** flow sensors as well as for other sensors (e.g. pressure, temperature, humidity) which are equipped with standard analog outputs.

The **SCHMIDT® LED Measured Value Display MD 10.015** is designed for the use inside closed rooms and is not suitable for outdoor use (risk of condensation on electronic parts). Moreover, the use in safety relevant applications are not allowed.

3 Mounting instructions

Dimensions

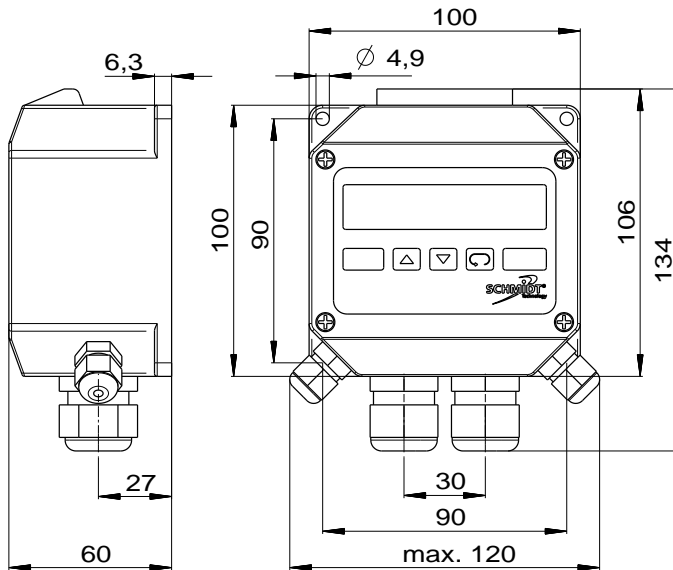

Figure 1: Dimensions of housing

Mounting

Typically, the **MD 10.015** is fixed to a wall by means of four screws (pattern of drilling see Figure 1).

Alternatively, **SCHMIDT Technology** offers a mounting kit that enables an easy installation of the device at pipes using hose clamps (article no. 531394).

Generally, please make sure that there is enough space (ca. 11 cm) to raise the upper part of the opened housing in order to establish electrical connection.

Lateral compression fittings

After installation of the measured value display, the compression fittings (included in delivery) can be mounted instead of the dummy plugs, if required.

Opening of housing

To establish electrical connection, the housing must be opened.



During electrical installation, ensure that no voltage is applied and inadvertent activation is not possible.

For this, loose the four screws of the housing completely. After that, the screws should be pulled out as far as possible and fixed with another left turn in the lid so that they do not block the opening of the lid.

Inside the open housing, some components that are susceptible to ESD are not protected against unintentional contact. Though the terminals are resistant to ESD, the other touchable parts of the electronic system (e.g. cover board with configuration jumpers, see Figure 3) are susceptible.



Take respective protective measures to avoid damages due to electrostatic discharge (ESD).

4 Electrical connection



The model **527330** uses low voltage (**115 / 230 VAC**).
If used improperly **danger of life!**



During electrical installation, ensure that no voltage is applied and inadvertent activation is not possible.



Only trained and qualified personnel must carry out the electrical installation.

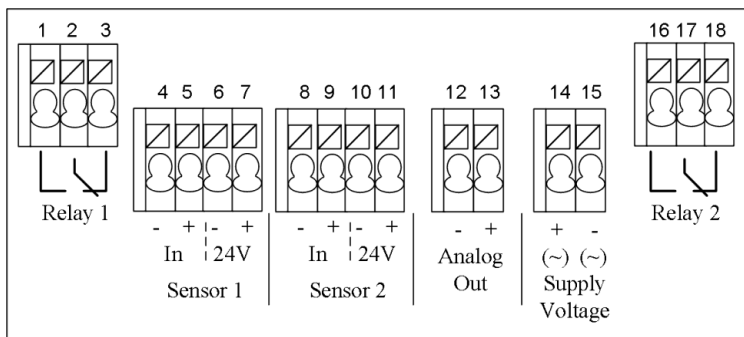

Figure 2: Terminals

Terminal	Designation	Function
1 - 3	Relay 1	Alarm output 1 (max. 250 VAC / 5 A)
4	Sensor 1 In-	Analog input 1: GND ¹
5	Sensor 1 In+	Analog input 1: Sensor signal (set jumper Ch.1 for configuration of signal modus)
6	Sensor 1 24V -	Supply voltage of sensor 1: GND
7	Sensor 1 24V+	Supply voltage of sensor 1: +24 VDC
8	Sensor 2 In-	Analog input 2: GND
9	Sensor 2 In+	Analog input 2: Sensor signal (set jumper Ch.2 for configuration of signal modus)
10	Sensor 2 24V -	Supply voltage of sensor 2: GND
11	Sensor 2 24V+	Supply voltage of sensor 2: +24 VDC
12	Analog Out -	AGND (galvanically isolated from GND)
13	Analog Out+	Analog output (galvanically isolated)
14 - 15	Supply voltage display	Version DC: (14) +24V, (15) GND Version AC: (14), (15)
16 - 18	Relay 2	Alarm output 2 (max. 250 VAC / 5 A)

Table 1: Pin assignment

The screwless spring terminals are designed for the reception of bare braids (no tinned ends or vein sleeves) of up to 1.5 mm².

¹ The potential "GND" is internally electrically coupled (but not "AGND").

Operating voltage

For proper operation, the **MD 10.015** requires depending of its version:

- Material No. 527330: 85 ... 250 VAC / 50 ... 60 Hz
- Material No. 528250: 23 ... 29 VDC



Only operate the measured value display within the defined operating voltage range and type.

The product can be destroyed; in worst case, **life is in danger**.

Supply voltage for sensor

The display provides a voltage source for the supply of a sensor (or even several sensors). The supplied voltage U_{Sensor} is nominal 24 VDC, its tolerance is type depending:

- Material No. 527330: $U_{Sensor} = 24 V \pm 15 \%$
- Material No. 528250²: $U_{Sensor} = U_{Operating_Display} - (1.2 V + 25 \Omega \cdot I_{Sensor})$

The load current I_{Sensor} is limited to 160 mA.

Analog inputs

The jumpers in the housing cover set the analog inputs of the display to the desired signal mode (current or voltage).

If the bridge is placed on the left contact pins (*Voltage*) a voltage signal is expected. If the plug connects the right pair of pins (*Current*), a current signal must be active.

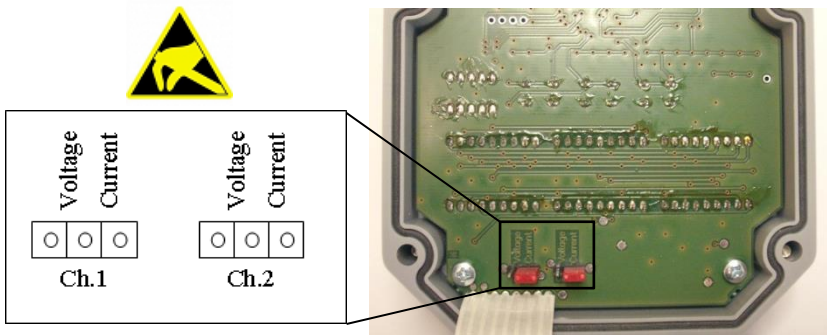

Figure 3: Jumper in housing cover for selecting signal mode

The input resistance is mode dependent:

- Current mode: $R_{IN} = 200 \Omega$
- Voltage mode: $R_{IN} = 12.5 k\Omega$

² Supply voltage of display is connected through, with a series diode & resistance of 25 Ω .

Analog output

The analog output of the **MD 10.015** is galvanically isolated from its own energy supply and the sensor supply (pin 13: *Analog Out+*; pin 12: *Analog Out-* \triangleq AGND; see Figure 2).

When using the display version with DC supply, the mass of the analog output (AGND) can be connected to that of the operating voltage (GND). However, the galvanic isolation is lost and a possible mass offset in the connecting cable can lead to a distortion of the output signal.

When using the display version with AC supply, the analog output must not be in contact with the supply voltage under any circumstances.

The load resistance R_L has to be connected to AGND:

- Current mode: $R_L \leq 400 \Omega$
- Voltage mode: $R_L \geq 1 \text{ k}\Omega$

In the configuration menu, beginning of signalization range without (0 mA or 0 V) or with offset (signal transmitting zero point: 4 mA) can be selected.

5 Operating modes

The LED measured value display can be operated in three different modes (parameter in configuration menu: "Selection of operating mode").

Standard mode

In standard mode (setting: *Std*) up to two sensor signals can be configured independently of each other. The volume quantity can be determined from the measured value of "Sensor 1" or the sum as well as the difference of both sensor flow velocity signals.

Bidirectional modes

The **SCHMIDT® LED Measured Value Display MD 10.015** and two uni-directional **SCHMIDT®** chamber head flow sensors can be used in addition to determine flow direction as well as flow volume from both directions.

The two sensors must be installed in the same tube at a distance of 10 times of the inner tube diameter and at an angle of 180° towards each other (see Figure 4).

Flows in measuring direction of "Sensor 1" are evaluated by the measured value display as positive flows.

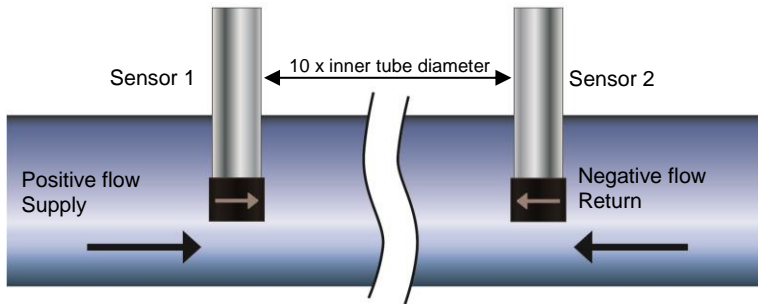

Figure 4: Bidirectional measurement

The measured value display can be configured for two measurement versions in bidirectional mode:

Version 1 (setting b_{i1}): Positive and negative flows are displayed. To determine the quantity, the positive flows are summed up and negative flows are subtracted.

Version 2 (setting b_{iP}): Positive flows are displayed, negative flows are suppressed. For determination of quantity, only positive flows are used.

6 Signalizations

Main display

Initially, the main display (see Figure 5) shows the status of the device:

Main display	State
i_{init}	Initialization of measured value display Duration approx. 5 s (after switch-on of supply voltage)
i_{lock}	Key lock activated
Err_{i1}	Error message from "Sensor 1"
Err_{i2}	Error message from "Sensor 2"
Flashing	Displayable range exceeded or undercut

Table 2 Initial status reports

Analog output

If one of the connected sensors indicates an error, the analog output of the **MD 10.015** will also signal an error:

- Signal range without offset (0 ... 20 mA / 0 ... 10 V):
In current mode the interface outputs 0 mA.
In voltage mode the output switches to 0 V.
- Signal range with offset (4 ... 20 mA):
The interface outputs 2 mA.

7 Startup

Before switching on the **SCHMIDT® Measured Value Display MD 10.015**, check whether the device is intact as well as installed correctly, both mechanically and electrically.

If the display is in the correct operational state, it is ready for operation approx. 5 seconds after switching on the supply voltage.

Operating and display elements

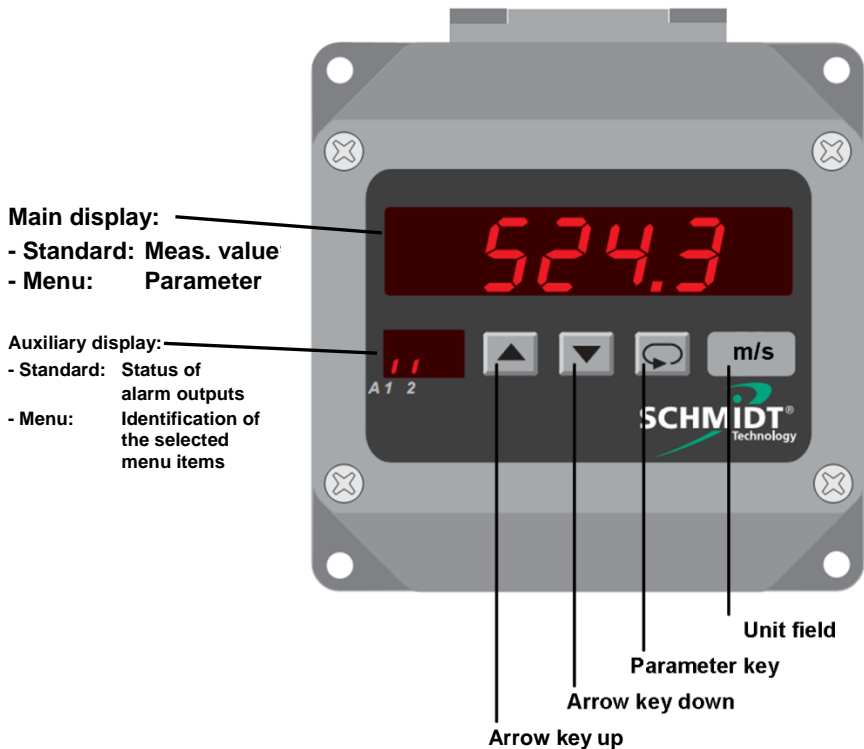

Figure 5: Operating and display elements

The labels included in the delivery can be glued to the unit field to indicate the desired measuring unit (e.g. m/s, m³/h ...).

Standard mode

After a successful initialization phase, the **MD 10.015** enters its standard operation mode as “Measured value display” (see Figure 5).

The main display shows the actual standard measurement value, the status of the alarm outputs are depicted in the auxiliary display (see Table 3).





Auxiliary display	State
	Alarm output 1: Not activated Alarm output 2: Not activated
	Alarm output 1: Activated Alarm output 2: Not activated
	Alarm output 1: Not activated Alarm output 2: Activated
	Alarm output 1: Activated Alarm output 2: Activated



Table 3 Alarm indication

Handling

The device can be operated by means of two different menus which are activated from standard mode using the parameter key :

- Shortly press the parameter key to open the display menu.
In this menu, the actual measured values of “Sensor 1” and “Sensor 2”, the quantity, the stored peaks (minimum and maximum) of the standard value as well as the switching points of the alarm outputs can be sequentially displayed by further pressing of the parameter key.
If the key isn't pressed for more than 2 minutes, the device returns automatically to standard mode.
- If the parameter key is pressed for more than 2 seconds, the configuration menu opens.

It can be used to configure both measuring inputs (sensor signals), bi-directional mode, calculation of volume flow and quantity, the analog output and both alarm outputs (details see chapter 8).

The menu items are selected sequentially by using the parameter key (short press). The settings of the currently selected menu item can be modified using the arrow keys ( .

The configuration menu is closed after the last menu item or, if no key is pressed for more than two minutes, it is exited automatically. It can also be quitted at any time by pressing the parameter key for a longer time (more than 2 seconds).

Table 4 shows an overview of the presentation and meaning of the different menu items.

Example application 1 – step by step

A flow sensor (meas. ranges: $w_N = 0 \dots 60$ m/s and $T_M = -40 \dots +85$ °C; both output signals: 4 ... 20 mA) is installed into a tube with DN 50.

Using the measured flow velocity w_N , the volume flow shall be calculated as primary value (in m³/h), and the flow quantity as a further result (in m³). Furthermore the medium temperature T_M of the sensor is recorded, both measured values are unfiltered.

The analog output of the display shall use 4 ... 20 mA to signal a scaled volume flow in m³/h: 4 mA = 0 m³/h and 20 mA = 200 m³/h.

In addition, a switching signal, delayed by 5 seconds is required as soon as 150 m³/h are exceeded, the hysteresis is 1 m³/h.

- Determination of the maximum volume flow based on the maximum flow velocity and the (inner) pipe diameter: $60 \text{ m/s} \triangleq 343 \text{ m}^3/\text{h}$

Available from the sensor's instruction manual or by means of the **SCHMIDT**[®] flow calculator:

www.schmidt-sensors.com/stroemungsrechner/volumenstrom-geschwindigkeit.html



- Install LED display at desired position
- Plug both jumpers for "current measurement" in housing cover
- Connect supply of sensor to LED display
- Connect analog outputs of sensor to LED display (analog output flow: "sensor 1"; analog output temperature: "Sensor 2")
- Connect analog output and relay output 1 of LED display
- Connect supply voltage of LED display and close its housing
- After switching on the supply voltage:
Initialization, followed by indication of an "unconfigured" measurement value on the main display
- Call-up configuration menu by pushing  for 2 seconds

Auxiliary display	Main display	Description
α^P	Std	Operating mode: Standard (only one flow sensor)
β^R	nl	Main display: Measuring value of input "Sensor 1"
F_i	oFF	Averaging of measurement values: Deactivated
Configuration of analog input 1		
αI	4 - 20	➤ Signal mode: 4 ... 20 mA (volume flow)
$d I$	00000.0	➤ Accuracy of indication: 1 decimal
$S I$	0.0	➤ Start value: 0 m ³ /h (\triangleq 4 mA)
$E I$	343.0	➤ End value: 343 m ³ /h (\triangleq 20 mA)

Auxiliary display	Main display	Description
Configuration of analog input 2		
n2	4 - 20	➤ Signal mode: 4 ... 20 mA (temperature T _M)
d2	00000.0	➤ Accuracy of indication: 1 decimal
52	-40.0	➤ Start value: -40 °C (± 4 mA)
E2	85.0	➤ End value: +85 °C (± 20 mA)
Configuration of volume quantity		
95	in l	➤ Summation: Measuring value "Sensor 1"
t	hour	➤ Time base: Hour (unit m ³ /h)
b 1	0.1	➤ Deadzone: 0.1 % of final measuring value (here: 0.343 m ³ /h) will not be added
9d	0000.00	➤ Accuracy of indication: 2 decimals
Configuration of alarm output 1		
4 1	in l	➤ Signal source: Measuring value of "Sensor 1"
42	onr	➤ Switching mode: Active when exceeding switching point
43	150.0	➤ Switching point: 150 m ³ /h
44	1.0	➤ Switching hysteresis: 1 m ³ /h (relais drops out when falling below 149 m ³ /h)
45	0.00.05	➤ Response delay: 5 s
46	0.00.05	➤ Release delay: 5 s
Configuration of alarm output 2		
2 1	oFF	Alarm output: Deactivated
Configuration of analog output		
a5	in l	➤ Signal source: Measuring value of "Sensor 1"
na	4 - 20	➤ Signal mode: 4 ... 20 mA
5a	0.00	➤ Start value: 0 m ³ /h (± 4 mA)
Ea	200.00	➤ End value: 200 m ³ /h (± 20 mA)
Lc	oFF	Control panel lock: Deactivated

After the final menu item, the configuration menu is left automatically for changing to the main display.

- Verification of indication values in display menu (short press of )

Auxiliary display	Main display	Description
..	12.8	Main display (standard measurement value): 12.8 m ³ /h
i1	12.8	Actual measured value of "Sensor 1": 12.8 m ³ /h
i2	23.9	Actual measured value of "Sensor 2": 23.9 °C
9t	0.20	Actual volume quantity: 0.2 m ³ Reset to 0 by using  for approx. 5 s
r1	4.597	Actual raw value "Sensor 1": 4.597 mA
r2	12.179	Actual raw value "Sensor 2": 12.179 mA
PP	45.8	Peak-value memory: - Maximum measured value of parameter that is selected for main display: 45.8 m ³ /h - Deletion of all maximum peak values of sensor by using  for approx. 5 s
nP	1.8	Peak-value memory: - Minimum peak value of parameter that is selected for main display: 1.8 m ³ /h - Deletion of all minimum peak values of sensor by using  for approx. 5 s
A1	150.0	Switching point of alarm output 1: 150 m ³ /h
A2	oFF	Alarm output 2: Deactivated

After the final menu item, the display menu is left automatically for changing to the main display.

Example application 2 – step by step

In a circular pipeline with DN 80 the consumption (m^3) has to be measured with two chamberhead flow sensors (measuring ranges: 0 ... 60 m/s, analog outputs: 4... 20 mA) according to Figure 4. Exceeding a flow volume of 100,000 m^3 shall be signalized by alarm output 1 without delays, using a hysteresis of 15 m^3 . The complete volume flow range that can be measured, from maximum negative to maximum positive values, should be signaled at the display's analog output in mode "current interface with offset".

- Determination of volume flow measuring range: 60 m/s \triangleq 920 m^3/h
Available from the sensor's instruction manual or by means of the **SCHMIDT®** flow calculator:

www.schmidt-sensors.com/stroemungsrechner/volumenstrom-geschwindigkeit.html



- Install LED display in required position
- Plug both jumper for "current measurement" in housing cover
- Install Sensor 1 and 2 according to Figure 4 in circular tube system
- Connect voltage supply of both sensors to LED display
- Connect analog flow outputs (w_N) of both sensors to LED display
- Connect analog output and relay output 1 of LED display
- Connect current supply of LED display and close its housing
- After switching on the supply voltage:
Initialization followed by indication of an "unconfigured" main value
- Call-up configuration menu by pushing  for 2 seconds

Auxiliary display	Main display	Description
αP	b_i	Operating mode: Bidirectional (both directions are counting)
bR	$9E4$	Main display measurement value: Flow volume (m^3)
F_i	αFF	Averaging of measurement values: Deactivated
Configuration analog input 1		
$n1$	$4 - 20$	➤ Signal mode: 4 ... 20 mA
$d1$	0000.00	➤ Accuracy of indication: 2 decimals
$S1$	0.00	➤ Start value: 0 m^3/h (\triangleq 4 mA)
$E1$	920.00	➤ End value: 920 m^3/h (\triangleq 20 mA)
Configuration analog input 2		
$n2$	$4 - 20$	➤ Signal mode: 4 ... 20 mA
$d2$	0000.00	➤ Accuracy of indication: 2 decimals
$S2$	0.00	➤ Start value: 0 m^3/h (\triangleq 4 mA)
$E2$	920.00	➤ End value: 920 m^3/h (\triangleq 20 mA)

Auxiliary display	Main display	Description
Configuration volume measurement		
t	hoUr	➤ Time base: Hour (unit m ³ /h)
bb	0.5	➤ Neutral zone (dead zone): If a flow is indicated without any flow rate, a false volume measurement can be prevented using a neutral zone. A neutral zone of 0.5 % corresponds to 4.6 m ³ /h in case of a measuring range of 920 m ³ /h. A volume flow < 4.6 m ³ /h is not considered in volume measurement.
9d	000000.	➤ The maximum volume shall be indicated on the 6-digit display => without any positions after the decimal point, there is the largest possible measuring range.
Configuration alarm output 1		
41	9t4	➤ Signal source: Flow volume (m ³)
42	onr	➤ Switching mode: Active when exceeding switching point
43	100000	➤ Switching point: 100,000 m ³
44	15	➤ Switching hysteresis: 15 m ³ (relais drops out when falling below 99,985 m ³)
45	0.00.00	➤ Response delay: None
46	0.00.00	➤ Release delay: None
Configuration alarm output 2		
21	oFF	Alarm output: Deactivated
Configuration analog output		
a5	b1	➤ Signal source: Flow volume (m ³ /h)
na	4 - 20	➤ Signal mode: 4 ... 20 mA
5a	-920.00	➤ Start value: -920 m ³ /h (\pm 4 mA)
Ea	920.00	➤ End value: +920 m ³ /h (\pm 20 mA)
Lc	oFF	Control panel lock: Deactivated

After the final menu item the configuration menu is left automatically for changing to the main display.

- Verification of indication values in display menu (short press of )

Auxiliary display	Main display	Description
11	1280	Main display measurement (standard) value: 1,280 m ³
b1	250.80	Bidirectional signal (volume flow): 250.80 m ³ /h
9t	1280	Actual quantity: 1,280 m ³ Reset to 0 by using  for approx. 5 s
r1	8.362	Actual raw value "Sensor 1": 8.362 mA
r2	13.232	Actual raw value "Sensor 2": 13.232 mA
PP	1280	Peak-value memory: - Maximum value of parameter that is selected for main display: 1,280 m ³ - Deletion of all maximum peak values by using  for approx. 5 s
nP	18	Peak-value memory: - Minimum value of parameter that is selected for main display: 18 m ³ - Deletion of all minimum peak values by using  for approx. 5 s
A1	100000	Switching point of alarm output 1: 100,000 m ³
A2	oFF	Alarm output 2: Deactivated

After the final menu item, the display menu is left automatically for changing to the main display.

8 Configuration menu

Information regarding the display



Menu item is only displayed if the respective configuration is selected

Flow diagram

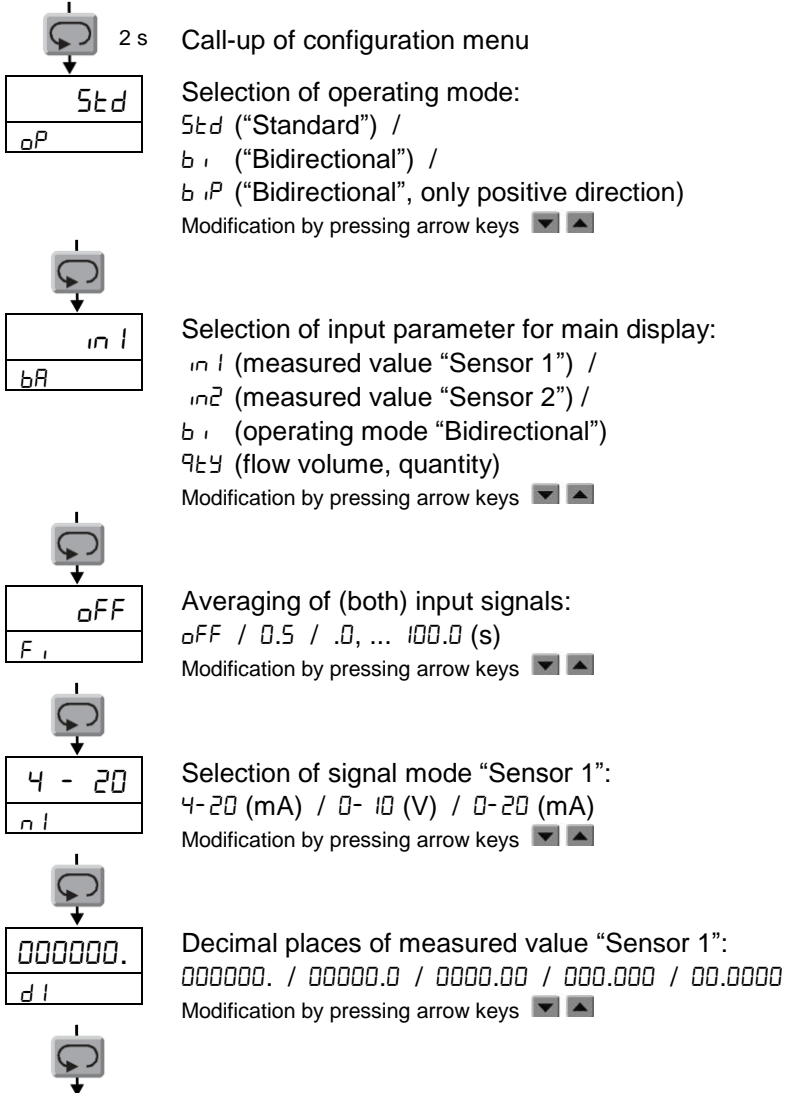

0.
51

Start value for measuring range "Sensor 1":
(e.g.: 0 ... 200 m³/h → 0)

Modification by pressing arrow keys ▼ ▲



200.
E1

End value for measuring range "Sensor 1":
(e.g.: 0 ... 200 m³/h → 200)

Modification by pressing arrow keys ▼ ▲



4 - 20
n2

Selection of signal mode "Sensor 2":

oFF / 4-20 (mA) / 0-10 (V) / 0-20 (mA)

Modification by pressing arrow keys ▼ ▲



0000.00
d2

Decimal places of measured value "Sensor 2":

000000. / 00000.0 / 0000.00 / 000.000 / 00.0000

(Only if input "Sensor 2" is activated)

Modification by pressing arrow keys ▼ ▲



-40.00
52

Start value for measuring range "Sensor 2":

(e.g.: -40 ... +85 °C → -40.00)

(Only if input "Sensor 2" is activated)

Modification by pressing arrow keys ▼ ▲



85.00
E2

End value for the measuring range of "Sensor 2":

(e.g.: -40 ... +85 °C → 85.00)

(Only if input "Sensor 2" is activated)

Modification by pressing arrow keys ▼ ▲



n1
95

Signal from which the volume will be calculated:

n1 (measured value "Sensor 1") /

dIFF (difference: "Sensor 1" - "Sensor 2") /

Add (sum: "Sensor 1" + "Sensor 2")

(not available in operating mode "Bidirectional")

Modification by pressing arrow keys ▼ ▲



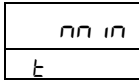

Time base unit for flow volume measurement:
SEc (second) / *nn in* (minute) / *hour* (hour)
 Modification by pressing arrow keys ▼ ▲

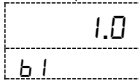

Neutral zone "Sensor 1":
 0 ... 9.9 (% of measuring range)
 Values within the neutral zone are not used for calculation of measuring volume
 (only available in operating mode "Standard")
 Modification by pressing arrow keys ▼ ▲

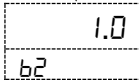

Neutral zone "Sensor 2":
 0 ... 9.9 (% of measuring range)
 Values within the neutral zone are not used for calculation of measuring volume
 (only available if the measured value of "Sensor 2" are used for calculation of the volume)
 Modification by pressing arrow keys ▼ ▲

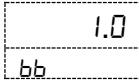

Neutral zone in operating mode "Bidirectional":
 0 ... 9.9 (% of measuring range)
 Values within the neutral zone are not used for calculation of measuring volume
 Modification by pressing arrow keys ▼ ▲

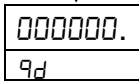

Number of decimal places of the measured volume:
000000. / *00000.0* / *0000.00* / *000.000* / *00.0000*
 Setting:

- *000000.*: Maximum quantity is "9999E9", minimum quantity is "-999E9"
- Others: Quantity is limited by indication area

Modification by pressing arrow keys ▼ ▲



OFF
41

Signal source for alarm output 1:

OFF (alarm output deactivated) /
in1 (measured value "Sensor 1") /
in2 (measured value "Sensor 2") /
bi (measured value in mode "Bidirectional") /
Qty (measured volume)

Modification by pressing arrow keys ▼ ▲



ONR
42

Switching behaviour alarm output 1:

ONR (switches when switching point is exceeded)
ONL (switches when dropping under switching point)

Modification by pressing arrow keys ▼ ▲



50.
43

Switching point alarm output 1:

Modification by pressing arrow keys ▼ ▲



0.50
44

Hysteresis alarm output 1 (four digits)

Modification by pressing arrow keys ▼ ▲



0.00.00
45

Response delay alarm output 1:

0.00.00 ... 9.00.00 (h.mm.ss)

Modification by pressing arrow keys ▼ ▲



0.00.00
46

Release delay alarm output 1:

0.00.00 ... 9.00.00 (h.mm.ss)

Modification by pressing arrow keys ▼ ▲



OFF
21

Parameterization of alarm output 2:



Identical to alarm output 1 (menu items 21 to 26)

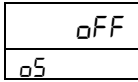



Signal source for analog output (reference signal):

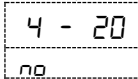

- oFF (analog output deactivated) /
- in1 (measured value "Sensor 1") /
- in2 (measured value "Sensor 2") /
- bir (measured value in mode "Bidirectional") /
- qLH (measured volume)

Modification by pressing arrow keys  



Signal mode of analog output:

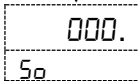

- 4-20 (mA) / 0-10 (V) / 0-20 (mA)

Modification by pressing arrow keys  



Start value of displayed range of analog output:

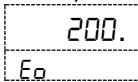

Number of decimal places is defined by configuration of the reference signal

Modification by pressing arrow keys  



End value of displayed range of analog output:

Number of decimal places is defined by configuration of the reference signal

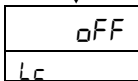

Modification by pressing arrow keys  



Key lock:

- oFF / on

Modifications in configuration menu as well as reset of peak value memory and measured volume are locked

Modification by pressing arrow keys  , even if "key lock" is active

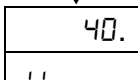

Return to the main display

Menu overview

The following Table 4 shows the representation of all possible menu items in the auxiliary display (see Figure 5).

	Description
<i>..</i>	Indication: Main display [m/s, m ³ /h, °C ...]
<i>R1</i>	Indication: Switching point alarm output 1
<i>R2</i>	Indication: Switching point alarm output 2
<i>b1</i>	Neutral zone sensor 1
<i>b2</i>	Neutral zone sensor 2
<i>bb</i>	Neutral zone bidirectional mode
<i>bR</i>	Selection main display value
<i>bι</i>	Indication: Measuring value bidirectional
<i>d1</i>	Decimal places input signal 1
<i>d2</i>	Decimal places input signal 2
<i>E1</i>	End value input signal 1
<i>E2</i>	End value input signal 2
<i>Eo</i>	End value analog output
<i>Fι</i>	Value averaging
<i>ι1</i>	Measuring value sensor 1
<i>ι2</i>	Measuring value sensor 2
<i>Lc</i>	Operation lock
<i>n1</i>	Signal mode input signal 1
<i>n2</i>	Signal mode input signal 2
<i>no</i>	Signal mode analog output
<i>nP</i>	Indication: Minimum measured value
<i>oP</i>	Selection operation mode
<i>o5</i>	Signal source analog output

	Description
<i>PP</i>	Indication: Maximum measured value
<i>qđ</i>	Decimals volume measurement
<i>q5</i>	Signal source volume measurement
<i>qE</i>	Indication: Volume measurement value
<i>r1</i>	Indication: Raw value input signal 1 [mA, V]
<i>r2</i>	Indication: Raw value input signal 2 [mA, V]
<i>51</i>	Start value input signal 1
<i>52</i>	Start value input signal 2
<i>5o</i>	Start value analog output
<i>t</i>	Time base volume measurement
<i>γ1</i>	Signal source alarm output 1
<i>γ2</i>	Switching behaviour alarm output 1
<i>γ3</i>	Switching point alarm output 1
<i>γ4</i>	Hysteresis alarm output 1
<i>γ5</i>	Response delay alarm output 1
<i>γ6</i>	Release delay alarm output 1
<i>21</i>	Signal source alarm output 2
<i>22</i>	Switching behaviour alarm output 2
<i>23</i>	Switching point alarm output 2
<i>24</i>	Hysteresis alarm output 2
<i>25</i>	Response delay alarm output 2
<i>26</i>	Release delay alarm output 2

Table 4

9 Service information

Eliminating malfunctions

The following Table 5 lists possible errors (error images). A description of the way to detect errors is given. Furthermore, the possible causes and measures to be taken to eliminate errors are listed.

Error image	Possible causes	Troubleshooting
Displays off & analog output to zero	Supply voltage U_B : <ul style="list-style-type: none"> ➤ No U_B present ➤ U_B (DC) wrong polarity ➤ U_B too low Measured value display defective	Supply voltage: <ul style="list-style-type: none"> ➤ Check if connected correctly to power supply ➤ Check voltage type (DC, AC) ➤ Check if there is supply voltage at terminals (cable break)
Measuring value too large / small	Incorrect configuration of sensor's measuring range	<ul style="list-style-type: none"> ➤ Check whether the analog measuring value is correct (r_1) ➤ Check configuration of start (S_1 / S_2) and end values (E_1 / E_2) of sensor's measuring range
Analog measured value (r_1) too large / small	Jumper for signal mode of analog input	➤ Set jumper according signal mode
	Input configuration	➤ Check input configuration (n_1 / n_2) according input signal
Analog signal too large / small	Output configuration	➤ Check configuration
Unexpected values at alarm output	Configuration alarm output	➤ Check configuration

Table 5

10 Technical data

Technical data	
Display	Main display: 7-segments LED red; 14.2 mm; 6 digits Sub display: 7-segments LED red; 7 mm; 2 digits
Input signals	Current: 0 / 4 ... 20 mA ($R_{IN} = 200 \Omega$) Voltage: 0 ... 10 V ($R_{IN} = 12.5 \text{ k}\Omega$)
Analog output	Galvanically isolated, short-circuit protected Permissible load resistance R_L in signal mode: Voltage ³ (0 ... 10 V): $R_L \geq 1 \text{ k}\Omega$ Current (0 / 4 ... 20 mA): $R_L \leq 400 \Omega$
Accuracy analog output	$\pm 0.2 \%$ of measured value
Relay outputs	2 x relay with changeover contacts (SPDT, potential-free) Max. 250 VAC / 5 A
Voltage supply for sensors	Short-circuit protected; current limited to max. 160 mA Mat.-no. 527330: 24 VDC $\pm 15 \%$ Mat.-no. 528250 ⁴ : See "Supply voltage for sensor" (p. 7)
Supply voltage of display	Mat. no. 527330: 85 ... 250 VAC / 50 ... 60 Hz Mat. no. 528250: 23 ... 29 VDC
Current consumption	Max. 8 VA
Operating temperature	-20 ... +60 °C
Storage/transport temperature	-40 ... +70 °C
Environmental conditions	Up to 95 % RH (non-condensing)
Connection	18 x spring clamps, bare braid, $\varnothing \leq 1.5 \text{ mm}^2$ 4 x compression fittings
Operating position	Arbitrary
Ingress protection	IP65 (housing and screw connections tightly sealed)
Protection class	II (touch proofed)
Housing material	Polyamide, glass-fiber reinforced (PA6-GF 15/15), color similar to RAL 7001
Weight	Approx. 370 g

Table 6

³ Current limited

⁴ Supply voltage of display is connected through, with a series diode & resistance of 25 Ω .

11 Declarations of conformity

SCHMIDT Technology GmbH herewith declares in its sole responsibility, that the product

SCHMIDT® LED Measured value Display MD 10.015

Part-Nos. **527 330** and **528 250**

is in compliance with the appropriate



European guidelines and standards

and



UK statutory requirements and designated standards.

The corresponding declarations of conformity can be download from **SCHMIDT®** homepage:

www.schmidt-sensors.com

www.schmidttechnology.de

Notes



SCHMIDT Technology GmbH

Feldbergstraße 1
78112 St. Georgen
Germany

Phone +49 (0)7724 / 899-0

Fax +49 (0)7724 / 899-101

Email sensors@schmidttechnology.de

URL www.schmidt-sensors.com
www.schmidttechnology.de