

Simply a question of
better measurement



**SCHMIDT[®] Flow Sensor
SS 20.651
Instructions for Use**

SCHMIDT® Flow Sensor SS 20.651

Table of contents

1	Important information.....	3
2	Application range.....	3
3	Mounting.....	4
4	Electrical connection.....	10
5	Commissioning.....	18
6	Service information.....	19
7	Dimensions.....	23
8	Technical table.....	24
9	Declarations of conformity.....	26

Imprint:

Copyright 2021 **SCHMIDT Technology GmbH**

All rights reserved

Version: 547608.02D

Subject to modifications

1 Important information

These instructions for use must be read completely and observed carefully, before putting the unit into operation.

- Any claims under the manufacturer's liability for damage resulting from non-observance or non-compliance with these instructions will become void.
- Tampering with the device in any way whatsoever - with the exception of the designated use and the operations described in these instructions for use - will forfeit any warranty and exclude any liability.
- The device is designed exclusively for the use described below (see chapter 2). In particular, it is not designed for direct or indirect protection of personal or machinery.
- **SCHMIDT Technology** cannot give any warranty as to its suitability for a certain purpose and cannot be held liable for errors contained in these instructions for use or for accidental or sequential damage in connection with the delivery, performance or use of this device.
- The following symbol has to be observed:



Danger warnings and safety instructions. Read carefully!

Non-observance of these instructions may lead to injury of personal or malfunction of the device.

2 Application range

The **SCHMIDT® Flow sensor SS 20.651** is designed for the stationary measurement of flow velocity as well as temperature of air. The sensor measures standard velocity w_N (unit: m/s) based on standard conditions of 1013.25 hPa and 20 °C. The output signal is linear and independent of pressure and temperature of the measured medium.

The basic version (without coating) is suitable only for clean air. Especially the occurrence of aggressive components (e.g. sulfur, chlorine, phosphor, etc.) can be done only on the customer's own responsibility.



Due to the high operating temperatures even low concentrations of aggressive components can lead to a significant reduction of the sensor's lifetime.

With optional coating (Parylene) the sensor exhibits a higher tolerance concerning pollution and an increased media resistance. The respective suitability has to be considered in each case due to the different environmental conditions.



When using the sensor outdoors, it must be protected against direct exposure to the weather.

3 Mounting

Determination of installation site

Correct measurements require a flow low in turbulence. This can be achieved by providing sufficiently long and straight distances without disturbances in front of and behind the sensor.

The minimum run-in and run-out distances depend on the degree of disturbance of the flow obstacle upstream (in front) of the measuring distance and the inner pipe diameter¹ D (see Figure 1 and Table 1).

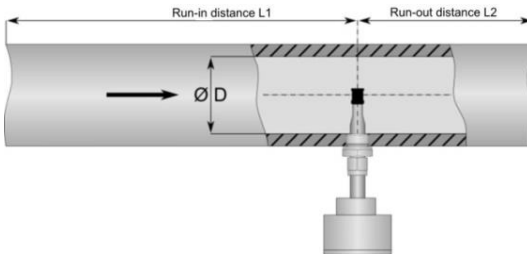

Figure 1

Flow obstacle upstream of measuring distance		Minimum distance length of	
		Run-in (L1)	Run-out (L2)
Light bend (< 90°)		10 x D	5 x D
Reduction, expansion, 90° bend or T-junction		15 x D	5 x D
Two 90° bends in one plane (2-dimensional)		20 x D	5 x D
Two 90° bends with 3-dimensional change in direction		35 x D	5 x D
Shut-off valve		45 x D	5 x D

Table 1 Minimum run-in and run-out distances depending on flow obstacles

¹ Minimum inner pipe diameter: 25 mm

Mounting method

The sensor **SS 20.651** is mounted by means of a compression fitting (content of delivery) which clamps the sensor probe by friction. Due to the different operating conditions (temperature and pressure range), there are different types (see Table 2):

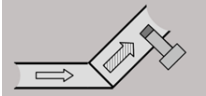
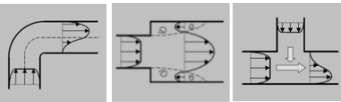
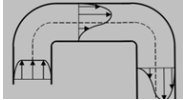
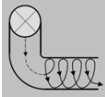
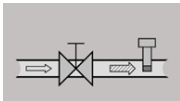
Max. temperature	Max. pressure	Fitting	Seal	Spare part no.
200 / 350 °C	atmospheric ²	brass	None	549311
200 °C	16 bar	1.4571	FKM	535092
350 °C	16 bar	1.4571	clamping ring	549312

Table 2 Types of compression fittings

Systems with overpressure

The **SS 20.651** is designed for atmospheric conditions (standard version), optionally for a working (over) pressure up to 16 bar. As long as the medium is operated with overpressure, make sure that:

- There is no overpressure in the system during mounting.



Mounting and dismantling of the sensor can be carried out only as long as the system is **in a depressurized state**.

- Only suitable pressure-tight mounting accessories are used.
- Appropriate safety devices are installed to avoid unintended discarding of the sensor due to overpressure.



For measurements in media with overpressure, appropriate safety measures must be taken to prevent unintended discarding of the sensor.

If other accessories than the delivered pressure protection kit or alternative mounting solutions are used, the customer must ensure the corresponding safety measures.



Pressure-tight mounting, fastening of the screw pipe connection and discarding protection must be checked before pressure is applied. These tightness checks must be repeated at reasonable intervals.



All components of the pressure protection kit (bolt, chain and bracket) have to be checked regularly for integrity.

² p = 700 ... 1,300 mbar

Thermal boundary conditions

With medium temperatures exceeding the permitted ambient temperature of the electronics (main enclosure), a free cooling section of the probe of at least 50 mm must be provided (see Figure 2) to prevent crosstalking of the hot medium temperature into the electronics located in the enclosure.

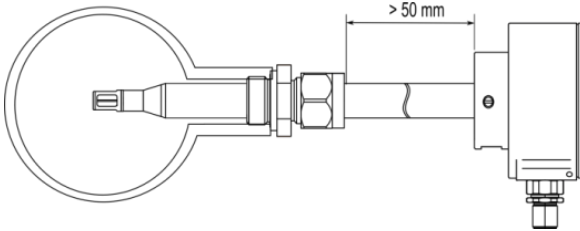

Figure 2



Measures must be taken by the customer to prevent an overheating of the electronics due to crosstalk of the medium temperature.

On the housing side, the sensor tube should project out of the measuring tube in free air (without insulation) by at least 50 mm (at sufficiently low ambient temperature).

Alignment of the sensor

The sensor head must be placed in the middle of the pipe (see Figure 1) and adjusted correctly relative to the flow direction. A sensor mounted in the wrong direction rotated by 180° leads to wrong (too high) measuring values. As installation aid, a flow arrow is applied to the enclosure cover, which must correspond to the flow direction.

Tilting of the measurement direction relative to the flow must not exceed $\pm 3^\circ$, otherwise it can lead to major measurement deviations³.



The sensor measures unidirectionally and must be adjusted correctly relative to the flow direction.

The axial tilting of the sensor head relative to the flow direction should not exceed $\pm 3^\circ$.

General note:



Do not use the alignment surface of the housing for mechanical adjustment, e.g. for locking.

There is a risk of damage to the sensor.

³ Deviations > 1 % of the measured value

Calculation of volume flow

A quasi-parabolic speed profile is formed over the pipe's cross-section under laminar⁴ conditions. Whereas the flow velocity at the pipe walls remains almost zero, in the middle of the pipe it reaches the optimum measuring point, its maximum w_N . This measurand can be converted into an average flow velocity $\overline{w_N}$ that is constant over the pipe cross-section with the aid of a correction factor the so-called profile factor PF.

The profile factor depends on the pipe diameter⁵ and is shown in Table 3.

PF	Pipe Ø		Volume flow [m³/h]					
	Inner [mm]	Outer [mm]	Min. @	@ Sensor measuring range				
			0.2 m/s	2.5 m/s	10 m/s	20 m/s	40 m/s	60 m/s
0.796	26.0	31.2	0.304	3.804	15.21	30.43	60.86	91.29
0.748	39.3	44.5	0.653	8.166	32.66	65.33	130.7	196.0
0.772	51.2	57.0	1.144	14.31	57.22	114.4	228.9	343.3
0.786	70.3	76.1	2.197	27.46	109.8	219.7	439.3	659.0
0.797	82.5	88.9	3.068	38.34	153.4	306.8	613.5	920.3
0.804	100.8	108.0	4.620	57.74	231.0	462.0	923.9	1,386
0.812	125.0	133.0	7.175	89.68	358.7	717.5	1,435	2,152
0.817	150.0	159.0	10.40	129.9	519.8	1,040	2,079	3,119
0.829	206.5	219.1	19.99	249.9	999.5	1,999	3,998	5,997
0.835	260.4	273.0	32.02	400.2	1,601	3,202	6,404	9,605
0.84	309.7	323.9	45.56	569.5	2,278	4,556	9,112	13,668
0.841	339.6	345.6	54.85	685.6	2,742	5,485	10,969	16,454
0.845	388.8	406.4	72.23	902.9	3,612	7,223	14,446	21,670
0.847	437.0	457.0	91.47	1,143	4,573	9,147	18,294	27,440
0.85	486.0	508.0	113.5	1,419	5,677	11,353	22,706	34,059
0.852	534.0	559.0	137.4	1,717	6,869	13,739	27,477	41,216
0.854	585.0	610.0	165.3	2,066	8,263	16,527	33,054	49,581
0.86	800.0		311.2	3,891	15,562	31,124	62,249	93,373
0.864	1,000		488.6	6,107	24,429	48,858	97,716	146,574
0.872	1,500		1,109	13,869	55,474	110,948	221,897	332,845
0.877	2,000		1,984	24,797	99,186	198,373	396,745	595,118

Table 3 Profile factors and volume flows

⁴ The term "laminar" means here an air flow low in turbulence (not according to its physical definition saying that the Reynolds number is < 2300).

⁵ Both inner air friction and sensor locking are responsible.

Thus, it is possible to calculate the standard volume flow of the medium using the measured standard flow velocity in a pipe with known inner diameter:

$A = \frac{\pi}{4} \cdot D^2$	D Inner diameter of pipe [m]
$\bar{w}_N = PF \cdot w_N$	A Cross-section area of pipe [m ²]
$\dot{V}_N = \bar{w}_N \cdot A$	w_N Flow velocity in the middle of the pipe [m/s]
	\bar{w}_N Average flow velocity in the pipe [m/s]
	PF Profile factor (for pipes with a circular cross-section)
	\dot{V}_N Standard volume flow [m ³ /s]

SCHMIDT Technology provides a "flow calculator" on its homepage for the calculation of flow velocity or volume flow in (circular) pipes or (rectangular) shafts for the different sensor types:

www.schmidt-sensors.com or www.schmidttechnology.de

Installation in systems with square cross-section

For most applications, two borderline cases can be distinguished with regard to flow conditions:

- Quasi-uniform flow field

The lateral dimensions of the flow-guiding system are approximately as large as its length in the flow direction and the flow velocity is small so that a stable trapezoidal⁶ speed profile of the flow is formed. The width of the flow gradient zone at the wall is negligible in relation to the chamber width so that a constant flow velocity can be expected over the whole chamber cross-section (the profile factor is in this case 1). The sensor must be mounted here in such a way that the sensor head is far away enough from the wall and measures in the area with the constant flow field.

Typical applications are:

- Exhaust ventilation shafts for drying processes
- Chimneys

⁶ A uniform flow field prevails in the largest part of the space cross-section.

- Quasi-parabolic flow profile

The system length is large compared to the cross-section surface and the flow velocity is so high that the ratios correspond to that of the circular pipe. This means that the same requirements apply here to the installation conditions.

Since the situation is similar to that in a pipe⁷, the volume flow in a square chamber can be calculated by equating the hydraulic diameter of both cross-section forms. The result for a rectangle according to Figure 3 is a hydraulic “pipe diameter” D_R :

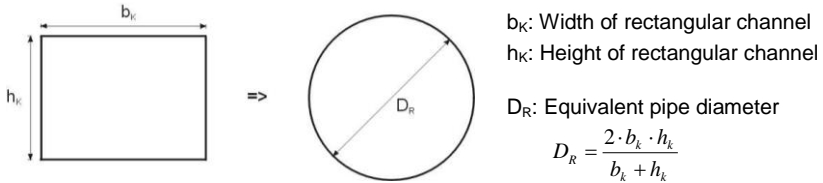

Figure 3

According to this, the volume flow in a shaft is calculated as:

$$A_R = \frac{\pi}{4} \cdot D_R^2 = \frac{\pi}{4} \cdot \left(\frac{2 \cdot b_K \cdot h_K}{b_K + h_K} \right)^2 = \pi \cdot \left(\frac{b_K \cdot h_K}{b_K + h_K} \right)^2$$

$$\bar{w}_N = PF \cdot w_N$$

$$\dot{V}_N = \bar{w}_N \cdot A_R = PF \cdot \pi \cdot \left(\frac{b_K \cdot h_K}{b_K + h_K} \right)^2 \cdot w_N$$

- b_K / h_K Width / height of square chamber [m]
- D_R Hydraulic inner diameter of square chamber [m]
- A_R Cross-section area of the equivalent pipe [m²]
- w_N Maximum flow velocity in the middle of the pipe [m/s]
- \bar{w}_N Average flow velocity in the pipe [m/s]
- PF Pipe profile factor
- \dot{V}_N Standard volume flow [m³/s]

Typical applications are:

- Ventilation shaft
- Exhaust air duct

⁷ The profile factors are equal for both cross-section forms.

4 Electrical connection



Make sure that no supply voltage is active during electrical installation and that the supply voltage cannot be switched on inadvertently.

The sensor is equipped with a plug-in connector which is firmly integrated in the housing (pin assignment see Table 4).

Number of connection pins: 8 (plus shield connection at the metallic housing)
 Type: Male
 Fixation of connecting cable: M12 thread (spigot nut at the cable)
 Type of protection: IP67 (with screwed cable)
 Model: Binder, series 763
 Pin numbering:



View on plug-in connector of sensor

Figure 4

Pin	Designation	Function	Wire color
1	Pulse 1	Output signal: Flow / volume (digital: Impulse)	White
2	U_S	Supply voltage: $24 V_{DC} \pm 20 \%$	Brown
3	Analogue T_M	Output signal: Temperature of medium (U / I)	Green
4	Analogue w_N	Output signal: Flow velocity (U / I)	Yellow
5	AGND	Reference potential for analogue outputs	Gray
6	Pulse 2	Output signal: Flow / volume (digital: Relay)	Pink
7	GND	Supply voltage: Ground	Blue
8	Pulse 2	Output signal: Flow / volume (digital: Relay)	Red
	Shield	Electromechanical shielding	Meshwork

Table 4

The specified wire colors are valid using a connecting cable delivered by **SCHMIDT® Technology GmbH**.

The analogue signals have an own AGND reference potential.

The metal sensor housing is indirectly coupled to GND (with a varistor⁸, parallel to 100 nF) and should be connected to a protective potential, e.g. PE (depending on the shielding concept).



The appropriate protection class III (SELV) respective PELV (EN 50178) has to be considered.

⁸ Voltage-dependant resistor (VDR); breakthrough voltage 27 V @ 1 mA

Operating voltage

The flow sensor **SS 20.651** is protected against reverse polarity of the operating voltage. For its intended operation, it requires a DC voltage of $24 V_{DC}$ with a tolerance of $\pm 20\%$.

Deviating values can lead to measurement errors or even defects and, therefore, should be avoided.



Operate the sensor only within the defined voltage range ($24 V_{DC} \pm 20\%$).

Undervoltage may result in malfunction, overvoltage may lead to irreversible damage.

The specifications for the operating voltage apply to the connection to the sensor. Voltage drops generated due to line resistances must be taken into account by the customer.

The operating current of the sensor (analogue signal currents included, without any of the impulse outputs) is normally approx. 50 mA. With pulse output, the required current value increases to max. 250 mA⁹.

Wiring of analogue outputs

Both analogue outputs, for flow and temperature, are designed as high-side drivers with "Auto-U/I" characteristic which are short circuit protected against both rails of the operating voltage.

The load resistance R_L must be connected between the corresponding signal output and the electronic reference potential AGND or GND of the sensor.

Depending on the value of resistance R_L , the signal electronics switches automatically between its operation as voltage interface (mode: U) or current interface (mode: I), hence the designation "Auto-U/I". The switching threshold is in range between 500 and 550 Ω (for details, refer to the next subchapter *Signalling of analogue outputs*).

However, a low load resistance value in voltage mode may cause significant voltage losses via line resistances (especially in the GND line), which can lead to measuring errors.



For voltage mode, a load resistance of at least 10 k Ω is recommended.

The maximum load capacity C_L is 10 nF.

⁹ Both signal outputs with 22 mA (maximum measurement values), both impulse outputs with maximum signal current, supply voltage minimal

The following points must be also taken into account:

- Use of only one analogue output
It is recommended to terminate both analogue outputs with the same resistance value, even if only one of the outputs is used.
- Unused analogue outputs
In this case, both outputs can remain disconnected or should be terminated with high impedance against (A)GND (with the same resistance value).
- Short circuit mode
In case of a short circuit against the positive rail of the supply voltage (+U_s), the signal output is switched off.
In case of a short circuit against the negative rail (A/GND) of the supply voltage, the output switches to current mode (R_L is calculated to 0 Ω) and provides the required signal current.
If the signal output is connected to +U_B via a resistance, the value R_L is calculated incorrectly and false signal values are caused.

Signalling of analogue outputs

- Switching characteristic “Auto-U/I”

Range of load value R _L	Signalling mode	Signalling range
≤ 500 (550) Ω	Current (I)	4 ... 20 mA
> 500 (550) Ω	Voltage (U)	0 ... 10 V

Table 5 Switching characteristic “Auto-U/I”

A hysteresis of approx. 50 Ω ensures a stable transition behavior, which is shown in Figure 5 below.

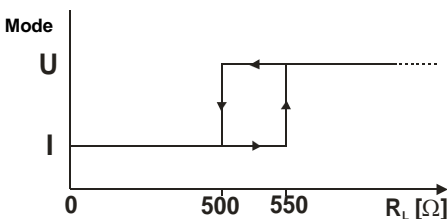

Figure 5

Depending on the set output signal, accuracy of the switching point detection can be reduced. Therefore, it is recommended to select the load resistance R_L in such a way that a secure detection can be maintained (≤ 300 Ω for current mode / ≥ 10 kΩ for voltage mode).

For measuring of R_L in an actual zero signal (voltage mode), the electronics generates test pulses that correspond to an effective value of approx. 1 mV. However, the latest measuring devices may trigger in response to such a pulse in the DC voltage measuring mode and display short-term measuring values of up to 20 mV. In this case, it is recommended to install an RC filter before the measuring input with a time constant of 20 ... 100 ms.

Severe interferences on the connection cable may shift the switching threshold out of specification. In this case the use of isolated amplifiers for the measuring signals are recommended.

- Error signalling

In current mode¹⁰, the interface output is 2 mA.

In voltage mode, the output switches to 0 V.

- Representation of measuring range

The measuring range of the corresponding measurand is mapped linearly to the signalling range of its associated analogue output, depending on the signal type.

For flow velocity measurement, it ranges from zero flow to the end of the measuring range $w_{N,max}$ (see Table 6).

Voltage mode (U)	Current mode (I)
$w_N = \frac{w_{N,max}}{10 V} \cdot U_{Out,w_N}$	$w_N = \frac{w_{N,max}}{16 mA} \cdot (I_{Out,w_N} - 4 mA)$

Table 6 Analogue signals for flow measurement

¹⁰ In accordance with the Namur specification

The measuring range of the medium temperature T_M starts at 0 °C and extends up to $T_{M,max} = +200 / +350$ °C (see Table 7).

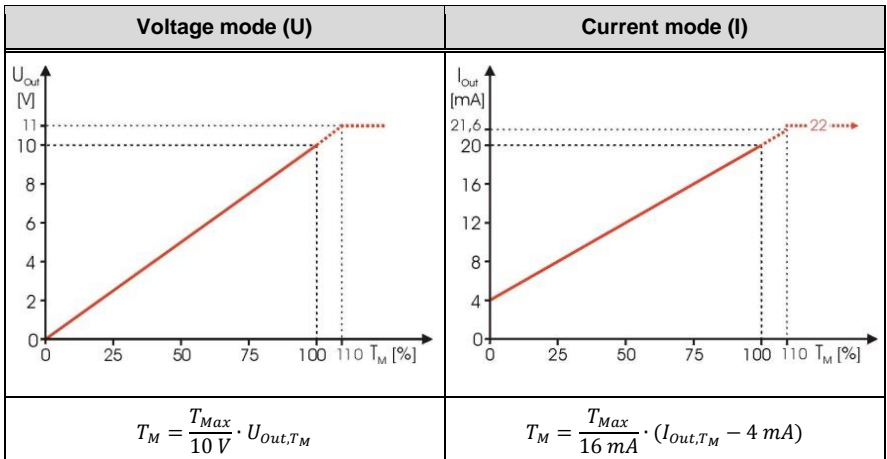

Table 7 Analogue signals for measurement of medium temperature

- Exceeding measuring range of flow velocity w_N
 Measuring values above $w_{N,max}$ are still output linearly up to 110 % of the signalling range (this corresponds to maximum 11 V or 21.6 mA, see images in Table 6). With even higher values of w_N , the output signal remains constant.
 Error signalling does not take place.
- Medium temperature T_M out of specification range
 Operation outside the specified limits can lead to damage to the sensor and, therefore, is considered as a critical error. Depending on the temperature limit¹¹, this leads to the following reaction (see also images in Table 7):

 - Medium temperature below $T_{M,min} = 0$ °C:
 The analogue output for T_M switches to error (0 V or 2 mA).
 The measuring function for flow velocity is switched off; its analogue output also signals an error (0 V resp. 2 mA).
 - Medium temperature above $T_{M,max} = +200 / +350$ °C:
 T_M is output in a linear way up to $T_{M,max} + 10$ %.
 Above this critical limit flow measurement is switched off and its analogue output switches to error (0 V or 2 mA). The signal output for T_M switches, contrary to standard error signalling, directly to the maximum values of 11 V resp. 22 mA.

¹¹ The switching hysteresis for decision threshold is approx. 5 K.

Wiring of pulse output (high-side driver)

The pulse output is current-limited, short-circuit protected and has the following technical characteristics:

Design:	High-side driver, open collector
Minimum high level $U_{S,H,min}$:	$U_S - 3\text{ V}$ (with maximum switching current)
Maximum low level $U_{S,L,max}$:	0 V (load R_L to GND required)
Short circuit current limit:	Approx. 100 mA
Maximum leakage current $I_{Off,max}$:	10 μA
Minimum load resistance $R_{L,min}$:	Depending on supply voltage U_S (see below)
Maximum load capacitance C_L :	10 nF
Maximum cable length:	100 m
Wiring:	

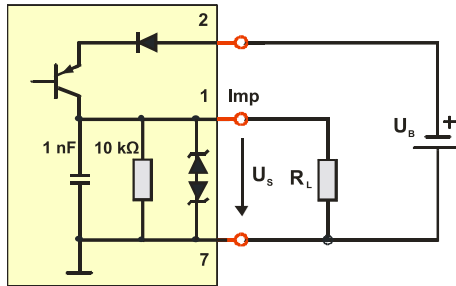

Figure 6

The pulse output can be used as follows:

- Direct driving of low-impedance loads (e.g. optocoupler, relays, etc.) with a current consumption of maximum 100 mA.

This allows calculating the minimum permitted (static¹²) load resistance $R_{L,min}$ depending on the operating voltage U_S :

$$R_{L,min} = \frac{U_{S,max} - 3\text{ V}}{0.1\text{ A}}$$

Example:

In case of the maximum permissible supply voltage of $U_{S,max} = 28.8\text{ V}$ the minimal load is $R_{L,min} = 258\ \Omega$.

Here the excessive heating power of the load has to be considered.

The pulse output is protected by various mechanisms:

- Current limiting:

The analogue current is limited to approx. 100 mA.

If the load value is too low, the output switches to chopping (cycle duration of 300 ms, with short interconnection phases of approx. 100 μs).

The maximum load capacitance C_L is 10 nF. A higher capacitance reduces the limit of the current limiter.

¹² Overcurrent peaks are absorbed by the short circuit limiter.



In case of a high capacitive load C_L , the inrush current impulse may trigger the quick-reacting short-circuit protection (permanently) although the static current requirement is below the maximum current $I_{S,max}$. An additional resistor connected in series to C_L can eliminate the problem.

- Protection against overvoltage:

The pulse output is protected against short-term overvoltage peaks (ESD, burst or surge) of both polarities by a TVS diode¹³.

Prolonged overvoltages destroy the electronics.



Overvoltages can destroy the pulse output.

Wiring of relay

The galvanically decoupled switching output is realized by a semiconductor relay with following technical characteristics:

Type:	SSR (PhotoMOS relay)
Maximum leakage current $I_{Off,max}$:	2 μ A
Maximum ON-resistance R_{ON} :	16 Ω (typ. 8 Ω)
Maximum switching current I_S :	50 mA
Maximum switching voltage U_S :	30 V _{DC} / 21 V _{AC,eff}
Wiring:	

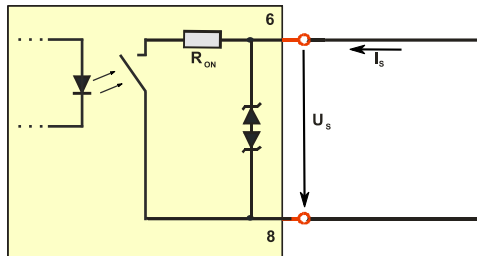

Figure 7

The relay output is protected against short-term overvoltage peaks (ESD, burst or surge) of both polarities by a TVS diode.

Prolonged overvoltages destroy the electronics.



Exceeding the specified electrical operating values lead to irreversible damage.

Protective measures for incorrect wiring or overload are not taken for this output.

¹³ Transient Voltage Suppressor Diode, breakdown voltage approx. 30 V, peak pulse capacity 4 kW (8 / 20 μ s)

Signalling of pulse outputs

Both pulse outputs represent the same information synchronously whereas two measurands are selectable:

- The actual flow velocity $w_N = 0 \dots w_{N,max}$ is mapped proportionally to the frequency¹⁴ range $f = 0 \dots f_{max}$ (see Figure 8):
 - Standard version: $f_{max} = 100 \text{ Hz}$
 - Optional: Selectable maximum frequency $f_{max} = 10 \dots 99 \text{ Hz}$

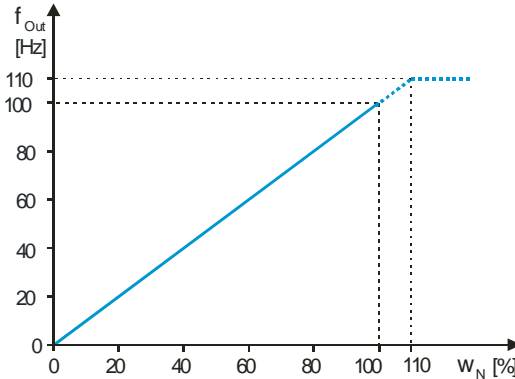

$$f_{max} = 10 \dots 100 \text{ Hz}$$

$$w_N = \frac{f}{f_{max}} \cdot w_{N,max}$$

$$\dot{V}_N = \frac{f}{f_{max}} \cdot \dot{V}_{N,max}$$

\dot{V}_N : Standard volume flow

Figure 8 Example for $f_{max} = 100 \text{ Hz}$

The volume flow and the pulse valence $V_{N,Imp}$ (= volume per pulse) can be determined on base of the output frequency, the measuring range of the sensor and the inner pipe diameter D:

$$\dot{V}_N = w_N \cdot PF \cdot A_D = w_N \cdot PF \cdot \frac{\pi}{4} \cdot D^2 ; \quad V_{N,Imp} = \frac{\dot{V}_{N,max}}{f_{max}}$$

- Another option supplies pulses with a fixed pulse valence of $1 \text{ m}^3/\text{pulse}$.

For this purpose, the inner pipe diameter must be specified when ordering (minimum inner pipe diameter: $D_{min} = 25 \text{ mm}$).

Exceeding the measuring range of flow w_N is still output up to 110 % of the measuring range. The output of higher flow values is limited to 110 % of the measuring range.

If an error occurs, 0 Hz respective no pulses will be output. The current initial state remains unchanged.

Note:

The relay can be used as a S0-Interface according DIN EN 62053-31¹⁵.

¹⁴ Duty cycle is 1 : !

¹⁵ Formerly: DIN 43864

5 Commissioning

The valid measuring ranges are specified on the rating plate.

After applying the supply voltage, the sensor signals the initialization of the measuring operation by means of all four Duo-LEDs (sequence: red, orange and green).

If the sensor detects a problem during initialization, it signals the problem according to Table 8. An extensive overview of errors and their causes as well as troubleshooting measures are listed in Table 9.

If the sensor is in the correct operational state, it switches to measuring mode after initialization. Flow velocity signalling (both LEDs and signal outputs) jumps briefly to maximum and settles down to the correct measuring value after approx. 10 seconds, provided that the sensor probe was already at medium temperature. Otherwise, the process will last longer until the sensor has reached the medium temperature.

LED display

No.	State	LED 1	LED 2	LED 3	LED 4
1	Ready for operation & flow < 5 % ¹⁶	●	○	○	○
2	Flow > 5 %	●	○	○	○
3	Flow > 20 %	●	●	○	○
4	Flow > 50 %	●	●	●	○
5	Flow > 80 %	●	●	●	●
6	Flow > 100 % (= Overflow)	●	●	●	●
7	Sensory element defective	◐	◐	◐	◐
8	Supply voltage too low	◐	◐	○	○
9	Supply voltage too high	○	○	◐	◐
10	Temperature of electronics too low	◐	○	○	◐
11	Temperature of electronics too high	○	◐	◐	○
12	Temperature of medium too low	●	◐	◐	●
13	Temperature of medium too high	◐	●	●	◐

Legend

- LED off
- LED shines green
- LED shines orange
- ◐ LED flashes red (approx. 2 Hz)

Table 8 LED signals of sensory functions

¹⁶ „%“ of measuring range of flow velocity

6 Service information

Maintenance

Contaminations of the sensor head lead to distortion of the measured value and can damage the sensor chip.

Therefore, the sensor head must be checked for contamination at regular intervals. If contaminations are visible, the sensor must be cleaned as described below and examined with respect to flow at a certain volume flow (calibration). Ideally, the entire characteristic line of the sensor should be calibrated by **SCHMIDT Technology**.



If the maintenance is performed not properly or not at the required intervals, the warranty will be rendered.

Cleaning of sensor head

If the sensor head is dusty or contaminated, it can be carefully cleaned by means of compressed air.



The sensor head is a sensitive measuring system. During manual cleaning proceed with great care.

In case of persistent deposits, the sensor chip as well as the interior of the chamber head can be cleaned carefully with the aid of residue-free drying alcohol (e.g. isopropyl alcohol) or soap water, using special cotton buds (example see Figure 9) or pipe cleaners.

Carefully insert the cotton pad between chamber head wall and sensor chip, then move it gently back and forth with controlled, minimal pressure on the chip.



Do not try to apply great force to the sensor chip (e.g. using cotton pads with a head that is too thick or making levering movements with the pad stick).

Mechanical overload may lead to irreversible damage.

Move the cotton pad with great care back and forth parallel to the surface of the chip to rub off the contamination. Use several cotton pads if required.



Figure 9 Example of cotton pads with narrow cleaning pads

For washing off the sensor element, a short rinsing with liquid (preferably using cleaning agents or alcohol, that dry out without leaving residues) is allowed. Immersion of the sensor head into liquids is not permitted.



Immersion into liquids is not permitted and can irreversibly damage the sensor head.

Before recommissioning, the sensor head must be completely dry. The drying process can be accelerated by gently blowing it off.

If this procedure does not help, the sensor must be sent to **SCHMIDT Technology** for cleaning or repair.

Eliminating malfunctions

The following Table 9 lists possible errors (error images). A description of the way to detect errors is given. Furthermore, possible causes and measures to be taken to eliminate errors are listed.



Causes of any error signalling have to be eliminated immediately. Significant exceeding or falling below the permitted operating parameters can result in permanent damage to the sensor.

































Error image				Possible causes	Troubleshooting
				Problems with supply voltage (U_S): <ul style="list-style-type: none"> ➤ No U_S present ➤ U_S has wrong polarity ➤ $U_S < 15\text{ V}$ Sensor defective	<ul style="list-style-type: none"> ➤ Is plug-in connector screwed on correctly? ➤ Is supply voltage connected to sensor (cable break, field connect)? ➤ Is the power supply unit suitable?
No LED is lit All signal outputs at zero					
Start sequence is repeated continuously (all LEDs red - yellow - green)				U_S unstable: <ul style="list-style-type: none"> ➤ Power supply unit is unable to supply inrush current ➤ Other consumers overload power supply ➤ Cable resistance too high 	<ul style="list-style-type: none"> ➤ Is the supply voltage at the sensor stable? ➤ Is the power supply unit powerful enough? ➤ Are the voltage losses over cable lines negligible?
				Sensor element defective	Return sensor for repair
				Supply voltage too low	Increase supply voltage
				Supply voltage too high	Reduce supply voltage
				Electronic temperature too low	Increase temperature of housing environment
				Electronic temperature too high	Decrease temperature of housing environment
				Medium temperature too low	Increase medium temperature
				Medium temperature too high	Decrease medium temperature
Flow signal w_N is too large / small				Measuring range too small / large I-mode instead of U-mode or vice versa Sensor element soiled	Check sensor configuration Check type or measuring resistance Clean sensor head
Flow signal w_N is fluctuating				U_S unstable Mounting conditions: <ul style="list-style-type: none"> ➤ Sensor head is not in the optimum position ➤ Inlet or outlet is too short Strong fluctuations of pressure or temperature	Check voltage supply Check mounting conditions Check operating parameters
Analogue signal voltage permanently at maximum				Load resistance at signal output connected to $+U_S$	Connect load to AGND
Analogue signal voltage permanently at zero				Error signalling Short circuit against (A)GND	Eliminate errors Eliminate short circuit

Table 9

Transport / Shipment of the sensor

For transport or shipping of the sensor, the supplied protective cap must be placed onto the sensor head. Avoid contaminations or mechanical stress.

Calibration

If the customer has made no other provisions, we recommend repeating the calibration at a 12-month interval. To do so, the sensor must be sent in to the manufacturer.

Spare parts or repair

No spare parts are available, since a repair is only possible at the manufacturer's facilities. In case of defects, the sensors must be sent in to the supplier for repair.

➤ **A completed declaration of decontamination must be attached.**

The appropriate form "Declaration of decontamination" form is enclosed with the sensor and can also be downloaded from

www.schmidt-sensors.com

under "Calibration Service Center".

Alternatively it can be downloaded from

www.schmidttechnology.de

under the heading "Product Downloads" in "Service & Support / Sensor Technology".

If the sensor is used in systems important for operation, we recommend you to keep a replacement sensor in stock.

Test and material certificates

Every new sensor is accompanied by a certificate of compliance according to EN 10204-2.1. Material certificates are not available.

Upon request, we shall prepare, at a charge, a factory calibration certificate, traceable to national standards.

7 Dimensions

Compact sensor

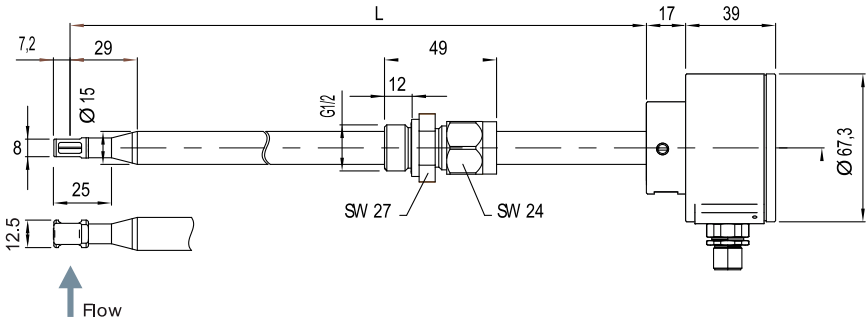

Figure 10

Remote sensor (including wall mounting bracket)

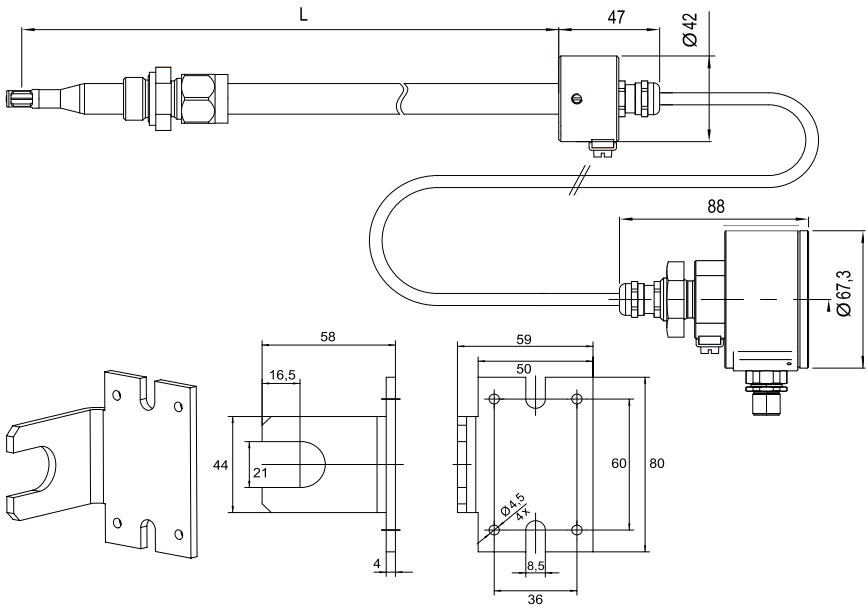

Figure 11

Dimensions in mm

8 Technical table

Measuring quantities	
Measured quantities	Standard velocity w_N based on standard conditions of 20 °C and 1013.25 hPa Medium temperature T_M
Medium to be measured	Clean air (without chemically aggressive content) Optional coating (Parylene) with increased resistance against soiling and aggressive media
Measuring range w_N	0 ... 2.5 / 10 / 20 / 40 / 60 m/s
Lower detection limit w_N	0.2 m/s (by $T_M = 20$ °C)
Measuring range T_M	0 ... +200 / +350 °C
Process data	
Measuring accuracy* w_N	± 3 % of m. v. + (0.4 % of final value; min. 0.08 m/s) ± 1 % of m. v. + (0.4 % of final value; min. 0.08 m/s)
Reproducibility w_N	± 1 % of measured value
Response time (t_{90}) w_N	3 s (jump from 0 to 5 m/s in air)
Temperature gradient T_M	< 8 K/min (by $w_N = 5$ m/s)
Recovery time constant	< 10 s (temperature jump T_M : $\Delta\vartheta = 40$ K by $w_N = 5$ m/s)
Measuring accuracy T_M ($w_N > 2$ m/s)	± 2 K ($T_M = 10 \dots 30$ °C) ± 4 K (remaining measuring range of T_M)
Operating temperature	
Sensor probe	0 ... +200 / +350 °C
Electronics	-20 ... +70 °C
Storage temperature	-20 ... +85 °C
Operating conditions	
Humidity range	Up to 95 % rel. humidity, non-condensing High humidity and high temperature at the same time can cause some deviations
Operating pressure	Atmospheric: 700 ... 1,300 mbar High pressure: 16 bar (over pressure)
Mounting	
Installation position	Arbitrary (under pressure preferred horizontal)
Mounting tolerance	$\pm 3^\circ$ parallel to flow direction (unidirectional)
Minimum pipe diameter	25 mm (depending on media temperature)
Construction	
Version	Compact / remote probe
Weight	Approx. 750 g (incl. fieldbus module)
Type of protection	Probe: IP54, housing: IP65
Probe length L	250 / 400 / 600 / 1000 mm (both versions)
Cable (remote connection)	Selectable: 1 ... 10 m (in steps of 1 m)

* Under reference conditions

Material	
Housing	Anodised aluminum
Sensor tube	Stainless steel 1.4571
Compression fitting	Stainless steel 1.4571 / brass / FKM (seal)
Sensor head	Platinum element (passivated glass), ceramics
Remote cable	Sleeve PUR, without halogens, UL
Coating (optional)	Parylene (only for $T_{M,max} = 200\text{ °C}$)
Operation	
Supply voltage U_s	24 VDC \pm 20 %
Current consumption	Typ. 50 mA (max. 250 mA)
Indication	4 x dual LEDs (green / red / orange)
Settling time	Approx. 10 s (after switch-on)
Protection class	III (SELV) or PELV (EN 50178)
Analogue outputs	
Measuring quantities	Flow velocity w_N , medium temperature T_M
Short circuit protection	Permanent (against both rails)
Signal type	Auto-U/I (automatic switching based on load R_L)
Switching Auto-U/I - Voltage output - Current output - Switching hysteresis	0 ... 10 V for $R_L \geq 550\ \Omega$ 4 ... 20 mA ¹⁷ for $R_L \leq 500\ \Omega$ 50 Ω
Maximum load capacitance	10 nF
Pulse outputs	
- Signalling:	Standard: $f \sim w_N$ ($f = 0 \dots 100\text{ Hz}$) Optional: $f \sim w_N$ ($f = 0\text{ Hz} \dots f_{max}$; $f_{max} = 10 \dots 99\text{ Hz}$) 1 pulse/m ³ (max. 100 Hz)
- Pulse output 1:	High-side driver, connected to supply voltage (without galvanic separation) High level: $> U_s - 3\text{ V}$ Short circuit current limitation: approx. 100 mA Leakage current: $I_{off} < 10\ \mu\text{A}$
- Pulse output 2:	Semiconductor relay (output galvanically separated) Max. 30 V _{DC} / 21 V _{AC,eff} / 50 mA
Standard connection	
Housing connector	Plug-in connector M12, 8-pin, male, screwed
Maximum cable length	Voltage signal: 15 m Current / impulse signal: 100 m

Table 10

¹⁷ Error signal: 2 mA

9 Declarations of conformity

SCHMIDT Technology GmbH herewith declares in its sole responsibility, that the product

SCHMIDT® Flow Sensor SS 20.651

Part-No. **546 650**

is in compliance with the appropriate



European guidelines and standards

and



UK statutory requirements and designated standards.

The corresponding declarations of conformity can be download from **SCHMIDT®** homepage:

www.schmidt-sensors.com

www.schmidttechnology.de



SCHMIDT Technology GmbH

Feldbergstraße 1
78112 St. Georgen
Germany

Phone +49 (0)7724 / 899-0

Fax +49 (0)7724 / 899-101

Email sensors@schmidttechnology.de

URL www.schmidt-sensors.com
www.schmidttechnology.de