

Simply the best!

Writing Instruments Technology
by SCHMIDT Technology





For more than 85 years **SCHMIDT Technology** has been developing and producing highly sophisticated solutions for major brands of writing instruments all over the world.

Solid and orientated to a qualitative expansion **SCHMIDT Technology** continuously developed into a company with international reputation. Visionary and innovative, our company introduces again and again new writing instruments technologies, which are always in line with the ever changing market requirements.

Are you looking for individual solutions and innovative writing ideas? Do you want to upgrade your existing product lines or realize new design concepts? If so, **SCHMIDT Technology** is the partner of your choice. Extensive R&D facilities, qualified experts and a vertical range of manufacturing enable us to realize your ideas quickly and flexible. This "time to market" approach allows you to generate quick turnover and to save your money.

The range of experience spans from standard mechanisms and writing components to complete writing instruments. In close dialogue with the customers **SCHMIDT Technology** develops and manufactures writing highlights on demand. The solutions are always tailored to the unique customer requirements.

SCHMIDT® Writing Instruments Technology

2 A complete writing instrument according to your ideas

4 **SCHMIDT® Advancing Mechanisms for**
One-colour writing instruments
Multicolour writing instruments
Multisystem writing instruments

10 **SCHMIDT® Pencil Mechanisms and Systems for**
Twist or push action

12 **SCHMIDT® Fountain Pen Technology**
Fountain pen nib units
Piston converters
Piston fountain pen units
RollingBall front parts
Cartridge-Rollerball-System

19 **SCHMIDT® Writing Units for**
easyFLOW
Capless System
RollingBall
FineLiner
Ballpoint pens in capillary, large capacity and pressurized technology

27 **Norms and Regulations**

28 **SCHMIDT® Writing Media**
Ball pen inks
Inks
SCHMIDT® Dosage System Technique

A complete writing instrument according to your ideas

SCHMIDT® Customer-Specific Solutions

Based on decades of experience in terms of development and production of writing systems, we are in the position to develop and produce customer-specific complete writing instruments as well. By doing this we can offer our customers the unique advantage to source all components from one single supplier: Starting with the customer's product idea via our development and construction by means of CAD/CAM through to the finished product. The project planning is fixed and coordinated by milestones agreed

upon with the customer. Our interdisciplinary thinking and acting enables us to turn the customer's ideas into series products, quickly and easily.

We thereby benefit from a large production depth and most modern production processes and methods. We are thus in the position to produce prototypes, pre-production sample series, as well as small and large series in consistent, high quality.

research

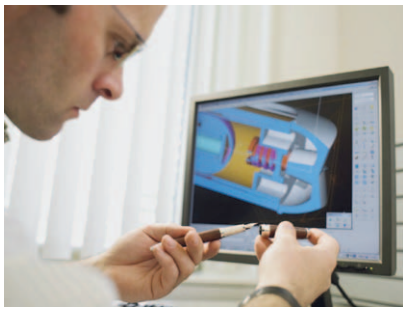

construction



idea



quality management



Production competence

- Tools and special devices in our own toolmaking department
- Technical and decorative plastic components
- CNC-turned parts from CNC-turning machine and CNC-turning and milling center
- Metal processing of stainless steel, brass, aluminium, titanium
- Stylus and laser engraving
- Guillochage
- Stamping
- Manual and machine polishing
- Grinding
- Blasting
- Manual and automated assembling

production

Surface materials and techniques

- Metal
- Plastic
- Wood
- Leather
- Lacquer coatings
- Electroplating
- Anodised coatings

SCHMIDT® System Mechanisms

The idea of creating a set turned out to be developing a system mechanism, which enables the use of a G2 large capacity refill as well as our system pencil mechanisms DSM 2005, DSM 2006, DSM 2007 and DSM 2008. Consequently the production of pen housings for the actions "twist" and "push button" as well as "sliding cap" is becoming very economical.

The system mechanism is mounted into the upper part of the pen. The front part of the housing can now take a G2 large capacity refill or a system pencil mechanism. Great advantage for the producer: create a writing set including a ballpoint pen and a mechanical pencil within one and the same housing.

Twist mechanisms are equipped with a friction sleeve avoiding an overtwisting of the mechanism. This offers an additional protection for your high-quality writing instrument.

SCHMIDT® One-colour Mechanisms

Actuating mechanisms for one-colour mechanisms are available for unlimited purposes: For twisting, pushing or sliding of all refills with ISO or special dimensions. You will find the most suitable actuating mechanism for your ballpoint pen in our programme. We are also specialized in developing special solutions according to your specifications.



Modules for SCHMIDT® System Mechanisms

Our KDM type push button mechanisms are designed to work with our G2 large capacity ballpoint pen refills as well as with our DSM 2005 – 2008 system pencil mechanisms.



Our DR type twist mechanisms (KS for ballpoint pens and DS for pencils) are compatible to each other. This means that only one pen housing is required for both writing systems.

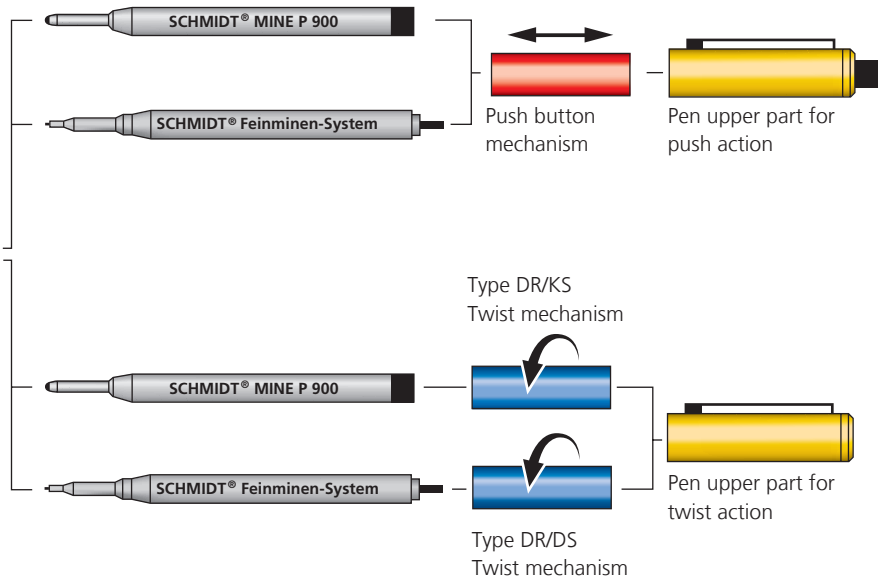

P 900

G2 refill with stainless steel tip with TC ball, writing strokes F, M and B writing colours black, blue, red and green



DSM 2005

For plug-in assembly, leads 0.5 mm or 0.7 mm



DSM 2006

For plug-in or screw-in assembly, leads 0.5 mm, 0.7 mm or 0.9 mm



DSM 2007

For screwing into the pen forepart, leads 0.5 mm or 0.7 mm



DSM 2008

For plug-in or screw-in assembly, leads 0.5 mm

SCHMIDT® System Twist Mechanisms



DR 403/KS
Twist mechanism for G2 refill



DR 403/DS
Twist mechanism for DSM 2007



eraser



clamping sleeve



DR 540/KS
Twist mechanism for G2 refill



DR 540/DS
Twist mechanism for DSM 2005 – 2008



eraser



clamping sleeve



DR 545/KS
Twist mechanism for G2 refill and Capless refill



DR 545/DS
Twist mechanism for DSM 2005 – 2008



eraser



clamping sleeve



DR 460/KS
Twist mechanism for G2 refill



DR 451/D
Twist mechanism for D refill



DR 451/DS
Twist mechanism for DSM 2005 – 2008



clamping sleeve



DR 470
Soft backspace twist mechanism for large capacity refills G2 and pencil mechanisms DSM 2005 – 2008. Moving back to its initial position, this mechanism is ideal for non-round writing instruments



clamping sleeve



DR 516/KS
Twist mechanism for G2 refill



DR 516/D
Twist mechanism for D refill



DR 516/DS
Twist mechanism for DSM 2005 – 2008



clamping sleeve



CDR 520
Combined twist mechanism for large capacity refills G2 and pencil mechanisms DSM 2005 – 2008



threaded central bush



eraser



clamping sleeve



DR 105/KS
Soft action twist mechanism for D refills



DRA 105
Twist pencil mechanism, with three leads diameter 0.5 mm, 0.7 mm or 0.9 mm



clamping sleeve

SCHMIDT® Push Button Mechanisms



KDM 820
Push button mechanism for large capacity refills DSM 2005 – 2008



clip bush



push button



KDM 700 S
Sliding cap mechanisms for G2 refill and pencil mechanisms DSM 2005 – 2008



threaded bush

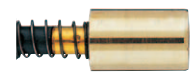

spring, top bush



SKM 192
Push button mechanism with cam for A2 and G2 refill



SKM 88 KS
Push button mechanism with cam for A2 and G2 refill



SKM 88 DS
Push button mechanism for pencil mechanisms DSM 2005 – 2008



threaded bush

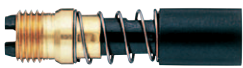

SMF/D
Push button mechanism with cam for D refills



SMF/CL
Push button mechanism with cam for G2 refills and Capless refills



CLD 825
Push button mechanism with cam and functional clip for Capless refills



SCHMIDT® Multicolour and Multisystem Mechanisms

Today consumers increasingly expect top quality and innovative writing instruments in an attractive design. Particular attention is obtained by writing instruments which allow to write in various colours or with several writing systems – like a small office. The possibilities offered by such leading edge products match in a special way today's consumers' requests.

SCHMIDT Technology is offering mechanisms that meet all consumers' needs. Ample combinations between ballpoint pens, pencil mechanisms and multicolour ballpoint pens are thinkable. Your customers' requirements will be accomplished by us in a perfect way.

SCHMIDT Technology stands for premium quality, perfect reliability and durability of all mechanisms for writing instruments. The advantages of **SCHMIDT Technology's** mechanisms for the customer are obvious.

The manifold advantages of the **SCHMIDT®** mechanisms are clear:

- the highest standard in precision and innovation based on decades of experience in the production
- optimal customer specific developments and adaptations of writing instruments mechanisms according to your individual requirements



SCHMIDT® Multicolour and Multisystem Mechanisms



Multisystem mechanism MDR 6

3-system twist mechanism with D refill, lead adapter for leads 0.5 mm and DataPen refill including eraser



Multisystem mechanism MDR 4

2-system twist mechanism with D refill and lead adapter for leads 0.5 mm



Multisystem mechanism MDR 3

2-system twist mechanism with D refill and lead adapter for leads 0.7 mm twist action lead feed allows multiple design options including eraser



Two-colour twist mechanism ZDR 1

2-colour twist mechanism with two D refills



Lead adapter

for MDR 4 and MDR 6 for leads dia 0.5 mm



Lead adapter

for MDR 3 for leads dia 0.7 mm



S 635

D refill with stainless steel tip and TC ball, writing colours stroke M: black, blue, red, green and orange; writing colours stroke F: black and blue; tip colouring is possible



S 630

D refill with stainless steel tip, persistent plastic colour key and TC ball, writing stroke M, writing colours black, blue, red and green



DataPen refill

for input on resistive touchscreens

SCHMIDT® Pencil Mechanisms and Systems

Push and twist pencils are traditional and at the same time fashionable. Especially in our computer age the fast and erasable pencil stroke is getting increasingly popular. Using a mechanical pencil to make entries in your agenda, taking quick notes during a conversation or making a sketch is most comfortable.

Today, **SCHMIDT® push pencil mechanisms** are mostly designed and produced according to customers' requirements. Your special demands and product profiles are always a challenge for us and our ambitious specialists.

SCHMIDT® push pencil mechanisms have proven their quality in many mechanical pencils of many renowned pen manufacturers during decades.

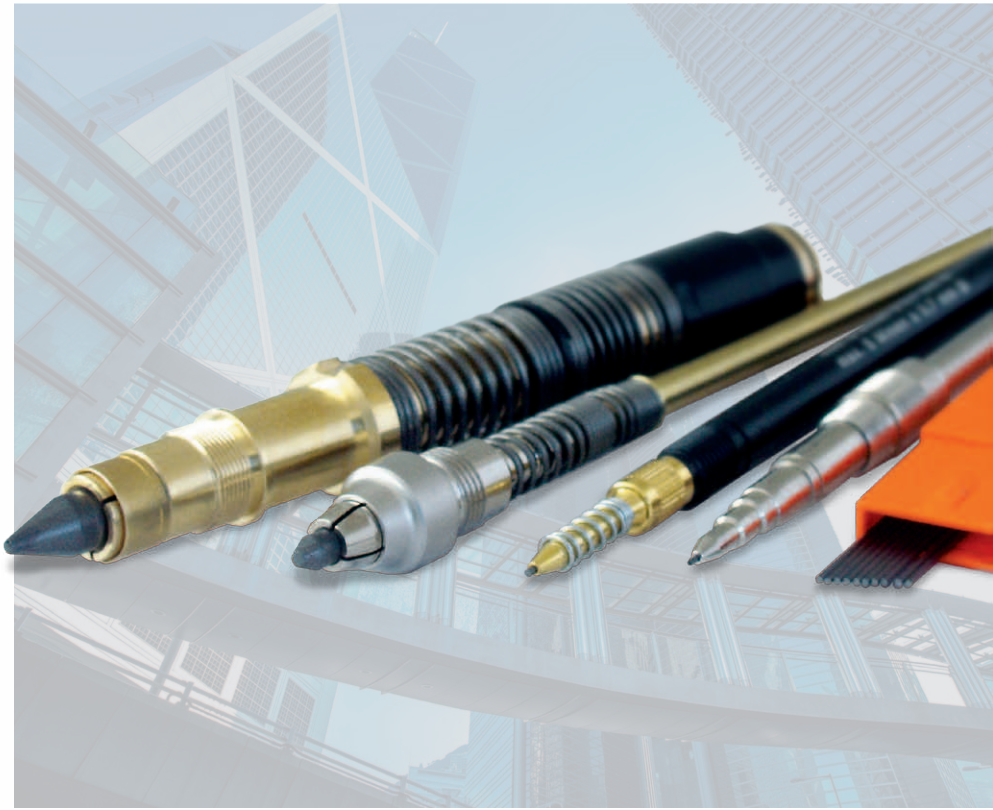

SCHMIDT® Push and Twist Pencil Mechanisms



DSM 5.6

Leads 5.6 mm,
leads are not included



DSM 3.15

Leads 3.15 mm, chrome-plated metal point
accessories: leads, erasers

Accessories DSM 3.15



threaded bush



push button



DBS 1

Metal twist mechanism, leads 0.9 mm
accessories: clamping sleeve, eraser



DBS 11

Twist mechanism, leads 0.9 mm
accessories: clamping sleeve, eraser



High-Polymer-Leads

in 12 pcs. plastic cassette 0.5 mm, 0.7 mm and 0.9 mm

SCHMIDT® Fountain Pen Technology

The culture of writing is celebrated by the use of the most prestigious writing instrument, the fountain pen. Therefore, we do not accept any compromise when the quality of your writing instrument is concerned.

SCHMIDT® fountain pen technology is offering a vast variety of choices for the design of your fountain pens. For decades **SCHMIDT Technology** has been developing and producing finest fountain pen nib units for the most famous brands of the world.

The **SCHMIDT® fountain pen** programme offers a wide array of different writing nibs of different materials and surface treatments.

This range is completed by a collection of piston converters and most recently a ready-to-be-build-in piston fountain pen unit.

In addition to **SCHMIDT® fountain pen technology**, **SCHMIDT® RollingBall** front parts have been developed, which allow the creation of sets.



1 housing = 2 writing instruments

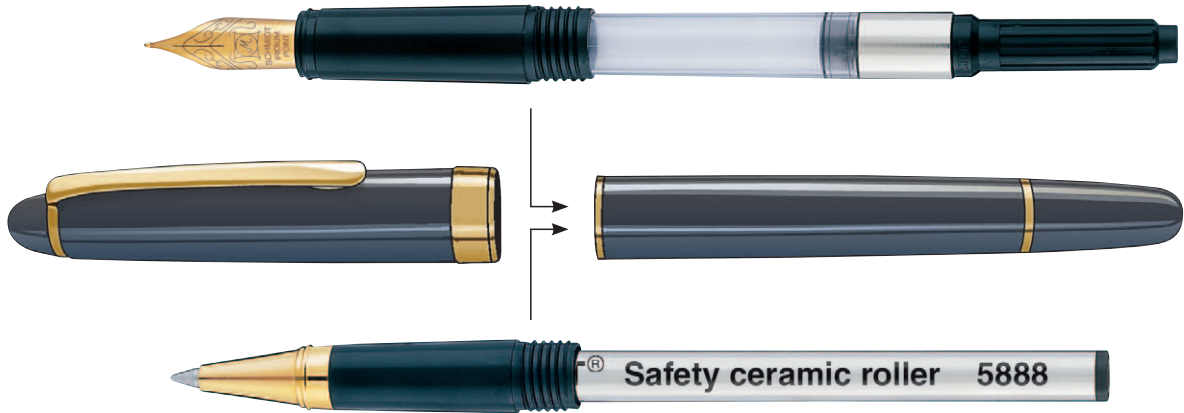

Nib wing span

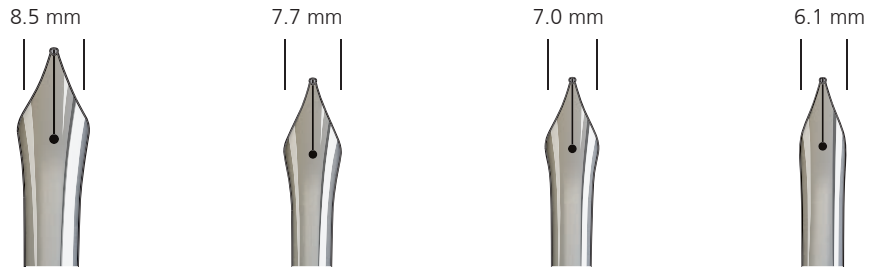

Model

FH 452	FH 341	FH 231 FH 241 FH 203	FH 204 FH 202 FH 201	FH 31 FH 41 FH 3	FH 4 FH 2 FH 1
--------	--------	----------------------------	----------------------------	------------------------	----------------------

Nib materials and executions



Solid gold
18K/14K
on request



Solid gold
18K/14K two-tone
on request



Stainless steel
two-tone
on request



Stainless steel
gold-plated



Stainless steel
blank

All nibs are available in the writing strokes EF, F, M and B.



SCHMIDT® Fountain Pen Technology

SCHMIDT® ink feeding system FH 452 ensures a reliable function in all situations. Even in the cabin of an aircraft, where the conditions are really extreme, this system guarantees absolute security.



1
...safe on everyday life conditions.
 Extensive tests in co-operation with Lufthansa have confirmed: **SCHMIDT® ink feeding systems** meet the highest safety requirements.



2
...flexible with decrease of pressure.
 With increasing flight altitude, the cabin pressure decreases and the **SCHMIDT® ink feeding system** fills. Even in this extreme situation **SCHMIDT® fountain pen technology** comes up to the highest requirements of a first-rate quality product.



3
...reliable in cruising altitude.
 In an altitude of 11000 m the cabin pressure decreases to a value corresponding to an altitude of 2500 m above sea level (approx. 750 mbar). Even under these extreme conditions the precise **SCHMIDT® ink feeding system** guarantees writing pleasure without leakage.



FH 452

Fountain pen nib unit with nib wing span 8.5 mm and fixation ring altitude stability 2500 m including cap sealing



KFH 450

Ready to mount piston fountain pen unit with nib wing span 8.5 mm, based on nib unit FH 452 including cap sealing



KFH 300



Ready to mount piston fountain pen unit with nib wing span 7.7 mm, based on nib unit FH 341 including cap sealing



FH 341  Fountain pen nib unit with nib wing span 7.7 mm including cap sealing



FH 231/FH 241   Fountain pen nib unit with /without decorative ring, for screw-in assembly in gripper jacket, nib wing span 7.0 mm including cap sealing

FH 31/FH 41   Fountain pen nib unit with /without decorative ring, for screw-in assembly in gripper jacket, nib wing span 6.1 mm including cap sealing

FH 203/FH 204   Fountain pen nib unit with /without decorative ring, for click-in assembly in gripper jacket, nib wing span 7.0 mm including cap sealing

FH 3/FH 4   Fountain pen nib unit with /without decorative ring, for click-in assembly in gripper jacket, nib wing span 6.1 mm including cap sealing

FH 202/FH 201   Complete fountain pen nib unit with gripper jacket with /without decorative ring, nib wing span 7.0 mm including cap sealing

FH 2/FH 1   Complete fountain pen nib unit with gripper jacket with /without decorative ring, nib wing span 6.1 mm including cap sealing

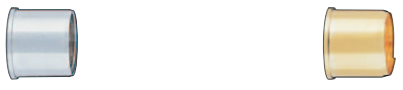

Central threaded bushes for fountain pen and RollingBall front parts chrome-plated, gold-plated

Inner sealing caps for fountain pens and RollingBall

The fountain pen nib units FH 1 – FH 241 are suitable for the use of fountain pens with "snap fit caps".

In this case, the sealing holds the cap on the pen housing. A sealing is supplied together with the fountain pen nib unit. For the fixation of the sealing in the fountain pen cap, the following versions are available:

Snap-fit sealing

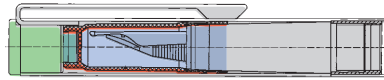

To be snapped into the turned part of the fountain pen cap

Tolerance compensation sealing

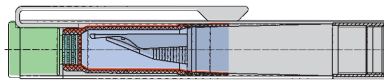

To be pressed with "compensation of the length tolerance" into the turned part of the fountain pen cap

Screw sealing

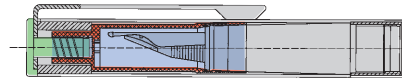

To be screwed into the turned part of the fountain pen cap

For nib wing spans of 6.1 mm and 7.0 mm, these inner sealing caps are available as "click" sealings with a sound, audible "click". For RollingBall front parts these types of sealings are also available without ventilation hole.

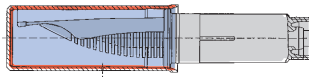

Inner sealing cap for FH 452 and KFH 450

provided for screw cap



Inner sealing cap for FH 341 and KFH 300

provided for screw cap

K6  Piston converter for screw-in assembly with two metal bands, gold or nickel-plated
crystal clear ink reservoir with elastic sealing
imprint on request

K5  Piston converter for plug-in assembly with two metal bands, gold or nickel-plated
crystal clear ink reservoir with elastic sealing
imprint on request

K2  Piston converter for plug-in assembly with one metal band, nickel-plated
imprint on request

K1  Piston converter for plug-in assembly

RG/G  RollingBall front part with gold-plated forepart

RG/C  RollingBall front part with chrome-plated forepart

Central threaded bushes  for fountain pen and RollingBall front parts chrome-plated, gold-plated

SCHMIDT® Cartridge-Rollerball-System

The **SCHMIDT® cartridge-rollerball-system PRS** is the innovative basis for new rollerball pen concepts in premium quality. Thanks to its specially developed low-wear ball tip, the **SCHMIDT® cartridge-rollerball-system PRS** comes up with previously unreachd durability.

The **SCHMIDT® cartridge-rollerball-system PRS** follows the functional principle of a fountain pen with common ink cartridges. The writing tip is used again and again and will not be discarded.

Writing instruments, fitted with the **SCHMIDT® cartridge-rollerball-system PRS** are therefore not only very economical but in particular environmentally friendly.

Talk to us, we support you with all our experience.



PRS in alternation with ventilated FP sealing cap



PRS plastic

Cartridge-Rollerball-System with 0.5 mm and 0.7 mm TC ball compatible with FH 41 and FH 241



PRS metal

Cartridge-Rollerball-System with 0.5 mm and 0.7 mm TC ball compatible with FH 41 and FH 241



SCHMIDT Technology, the specialist in writing technology, presented a completely new class of writing instruments. The new generation of writing systems is called **SCHMIDT® easyFLOW** and has found a very big response.

More easily than any other writing system the tip of the **SCHMIDT® easyFLOW** glides over the paper. The ink flow starts instantly even after a longer pause of writing. Easily, as never seen before, you get a writing that is regular, strong, precise and clean.

SCHMIDT® easyFLOW combines the advantages of the well-known ballpoint refill with those of a rollerball refill creating a completely new market segment in the field of writing instruments.

SCHMIDT® easyFLOW made by **SCHMIDT Technology** is actually predestinated to take high-valued writing instruments out of the middle class and to meet the demands of exigent customers for a premium writing system. The **SCHMIDT® easyFLOW** is available in the large capacity refill size G2 as per the standard DIN ISO 12757.

Thanks to the excellent cap-off time, cap sealings are not required. Therefore the **SCHMIDT® easyFLOW** is especially suitable for retractable push and twist pens without cap – and this without using any safety mechanisms.



easyFLOW 9000



New refill type in G2 format for a smooth and easy writing feeling. Stainless steel tip with 0.8 mm TC ball, including tip protection cap writing colours black and blue



easyFLOW 9000



New refill type in G2 format for a smooth and easy writing feeling. Stainless steel tip with 1.0 mm TC ball, including tip protection cap writing colours black and blue

SCHMIDT® Capless System

The **SCHMIDT® Capless System** is an innovative system for smooth and elegant writing. This system combines the individual writing characteristics of a fountain pen with the convenience of a ballpoint pen. You do not need a protection cap for this anymore. While the ink is drying quickly on the paper, it does not so within the refill itself – for more than one year!

The development of the **SCHMIDT® Capless System** proved once more the innovation power of our company. Our high degree of creativity and technical performance enables us to continuously give impulses to the writing instruments industry. This is crucial for our customers to maintain and develop their leading position on the market.



S 8125



length 108.6 mm
Ø 6.9 mm

Capless rollerball refill with metal tube and front section, stainless steel tip with 0.5 mm ceramic ball writing colours black and blue, one year cap-off time



S 8126



length 108.6 mm
Ø 6.9 mm

Capless rollerball refill with metal tube and front section, stainless steel tip with 0.6 mm ceramic ball writing colours black, blue, red and green, one year cap-off time



S 8127

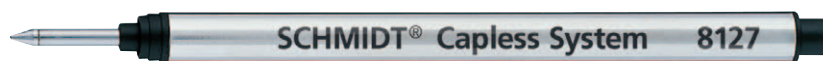

length 108.6 mm
Ø 6.9 mm

Capless rollerball refill with metal tube and front section, stainless steel tip with 0.7 mm ceramic ball writing colours black, blue, red and green, one year cap-off time



S 8120

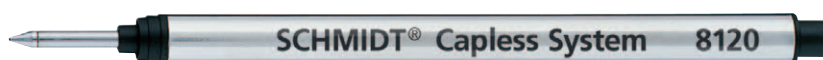

length 108.6 mm
Ø 6.9 mm

Capless rollerball refill with metal tube and front section, stainless steel tip with 1.0 mm ceramic ball writing colours black and blue, one year cap-off time

All stainless steel tips are lead-free.

SCHMIDT® Capless System Technique

P 8125

SCHMIDT® Capless System P 8125

length 97.5 mm
Ø 6.9 mm

Capless rollerball refill with metal tube and front section, stainless steel tip with 0.5 mm ceramic ball writing colours black, blue, red and green, one year cap-off time

P 8126

SCHMIDT® Capless System P 8126

length 97.5 mm
Ø 6.9 mm

Capless rollerball refill with metal tube and front section, stainless steel tip with 0.6 mm ceramic ball writing colours black, blue, red and green, one year cap-off time

P 8127

SCHMIDT® Capless System P 8127

length 97.5 mm
Ø 6.9 mm

Capless rollerball refill with metal tube and front section, stainless steel tip with 0.7 mm ceramic ball writing colours black, blue, red and green, one year cap-off time

P 8120

SCHMIDT® Capless System P 8120

length 97.5 mm
Ø 6.9 mm

Capless rollerball refill with metal tube and front section, stainless steel tip with 1.0 mm ceramic ball writing colours black and blue, one year cap-off time

8126

SCHMIDT® Capless System mini 8126

length 76 mm
Ø 6.9 mm

Capless rollerball refill for small pens with metal tube and front section stainless steel tip with 0.6 mm ceramic ball writing colours black, blue

DR 545/KS
Soft action twist mechanism for G2 large capacity and Capless refills

SMF/CL
Push button mechanism with cam for G2 large capacity and Capless refills

CLD 825
Push button mechanism with cam and functional clip for SCHMIDT® Capless System



SCHMIDT® Liquid Ink Refills

SCHMIDT® Liquid Ink Refills offer great performance and easy handling. This convenience is owed to an easy and smooth gliding over the paper. Pen manufacturers all over the world rely on liquid ink refills from **SCHMIDT Technology**.

SCHMIDT® Liquid Ink Refills with plastic tube are an affordable alternative, and proved their quality in millions of pens worldwide. They are equipped with an end plug in their individual writing colour and a protection cap in the colour of the writing system.

SCHMIDT® Safety Refills avoid drying up by means of a sophisticated ventilation system and are designed for use in writing instruments without perfect sealing caps.



RST 6126



length 110.6 mm
Ø 6.3 mm

Reservoir based refill with metal tube and stainless steel front section
stainless steel tip with 0.6 mm ball
writing colours black, blue



RST 6124



length 110.6 mm
Ø 6.3 mm

Reservoir based refill with metal tube and stainless steel front section
stainless steel tip with 0.7 mm ball
writing colours black, blue



RB 117



length 110.2 mm
Ø 6.3 mm

Reservoir based economy refill with plastic tube
plastic tip with 0.7 mm TC ball
writing colours black, blue

All stainless steel tips are lead-free.

SCHMIDT® Safety Rolling Ceramic and Safety RollingTube Refills

The safety technology features extended shelf-life characteristics
It is therefore particularly suited for use in pens without cap sealing.

- | | |
|---|---|
| 
SRC 5888 EF
 |  <p>SCHMIDT® Safety ceramic roller 5888 EF length 110.6 mm
 \varnothing 6.3 mm
 Safety Ceramic RollingBall refill with metal tube, stainless steel tip with 0.5 mm ceramic ball writing colours black and blue</p> |
| 
SRC 5888 F
 |  <p>SCHMIDT® Safety ceramic roller 5888 F length 110.6 mm
 \varnothing 6.3 mm
 Safety Ceramic RollingBall refill with metal tube, stainless steel tip with 0.6 mm ceramic ball writing colours black, blue, red and green</p> |
| 
SRC 5888 M
 |  <p>SCHMIDT® Safety ceramic roller 5888 M length 110.6 mm
 \varnothing 6.3 mm
 Safety Ceramic RollingBall refill with metal tube, stainless steel tip with 0.7 mm ceramic ball writing colours black, blue, red, green, magenta, turquoise, violet, light-green, pink and orange</p> |
| 
SRC 5888 B
 |  <p>SCHMIDT® Safety ceramic roller 5888 B length 110.6 mm
 \varnothing 6.3 mm
 Safety Ceramic RollingBall refill with metal tube, stainless steel tip with 1.0 mm ceramic ball writing colours black and blue</p> |
| 
SRC 888 EF
 |  <p>SCHMIDT® Safety ceramic roller 888 EF length 110.6 mm
 \varnothing 6.3 mm
 Safety Ceramic RollingBall refill with plastic tube, stainless steel tip with 0.5 mm ceramic ball writing colours black and blue</p> |
| 
SRC 888 F
 |  <p>SCHMIDT® Safety ceramic roller 888 F length 110.6 mm
 \varnothing 6.3 mm
 Safety Ceramic RollingBall refill with plastic tube, stainless steel tip with 0.6 mm ceramic ball writing colours black, blue, red and green</p> |
| 
SRC 888 M
 |  <p>SCHMIDT® Safety ceramic roller 888 M length 110.6 mm
 \varnothing 6.3 mm
 Safety Ceramic RollingBall refill with plastic tube, stainless steel tip with 0.7 mm ceramic ball writing colours black, blue, red, green, magenta, turquoise, violet, light-green, pink and orange</p> |
| 
SRC 888 B
 |  <p>SCHMIDT® Safety ceramic roller 888 B length 110.6 mm
 \varnothing 6.3 mm
 Safety Ceramic RollingBall refill with plastic tube, stainless steel tip with 1.0 mm ceramic ball writing colours black and blue</p> |
| 
SRT 5285
 |  <p>SCHMIDT® Safety rolling tube 5285 EF length 110.6 mm
 \varnothing 6.3 mm
 Safety RollingTube refill with metal tube and stainless steel needlepoint tip with 0.5 mm TC ball writing colours black, blue</p> |

All stainless steel tips are lead-free.

SCHMIDT® FineLiner / Fiber refill

SCHMIDT® FineLiner / Fiber refill are characterized by a very good storage stability. The specially developed inks are suitable for longer cap-off times.



FL 6040 F



length 110.6 mm
Ø 6.3 mm

Reservoir based refill with metal tube and stainless steel front section extruded spring loaded 0.8 mm (F) writing colours black, blue, red, green, magenta, turquoise, violet, light-green, pink and orange



FL 6040 M



length 110.6 mm
Ø 6.3 mm

Reservoir based refill with metal tube and stainless steel front section extruded spring loaded 1.0 mm (M) writing colours black, blue, red, green, magenta, turquoise, violet, light-green, pink and orange



FM 5020



length 110.6 mm
Ø 6.3 mm

Reservoir based refill with metal tube and plastic front section writing colours black and blue



All stainless steel tips are lead-free.

SCHMIDT® MegaLine pressurized technology turns everything upside down!

These highly sophisticated writing modules are based on an inside over pressure. This enables not only a writing upside down or under the most extreme environmental conditions, but also a writing with highest speeds.

The **SCHMIDT® MegaLine** system allows to write and to draw in each possible situation without any problems – this is really cutting-edge refill technology.

Writing instruments equipped with **SCHMIDT® MegaLine** pressurized refills are a reliable partner for their owner – always and everywhere.

Thanks to their air tight system, these refills have a literally unlimited shelf-life. They are equipped with stainless steel tips manufactured with utmost precision as well as special ball pen inks developed exclusively for this purpose.



P 950



G2 refill with stainless steel tip, writing stroke M
writing colours black, blue

S 4889



Length 89 mm, stainless steel tip, writing stroke M
writing colours black, blue

S 4876



Length 76 mm, stainless steel tip, writing stroke M
writing colours black, blue

S 620



D refill with stainless steel tip, writing stroke M,
writing colour blue

All stainless steel tips are lead-free.

SCHMIDT® Ballpoint Refills

As the first manufacturer in Germany **SCHMIDT Technology** has been developing and producing ballpoint refills since more than half a century. The long experience in development combined with special production techniques resulted in products with remarkable characteristics. Many renowned writing instruments manufacturers worldwide assemble their ballpoint pens with refills coming from our company.

SCHMIDT® Ballpoint Refills of the top class are equipped with high-quality stainless tips and TC balls.

SCHMIDT® Ballpoint Refills of the standard class are equipped with brass or nickel silver tips.



Softline



G2 large capacity refill with stainless steel tip and TC ball, extra soft writing writing colours black and blue

P 900



G2 large capacity refill with stainless steel tip and TC ball, writing strokes F, M and B writing colours black and blue

P 900



G2 large capacity refill with stainless steel tip and TC ball, writing stroke M writing colours red, green, magenta, turquoise and violet

S 635



D refill with stainless steel tip and TC ball, writing colours stroke M: black, blue, red, green and orange; writing colours stroke F: black and blue; tip colouring is possible

S 630



D refill with stainless steel tip, persistent plastic colour key and TC ball, writing stroke M writing colours black, blue, red and green

S 700



A2 refill, writing stroke M, writing colours black, blue

S 700/s silver white



A2 refill, writing stroke M, erasable silver white ink, writes on light and dark surfaces

All stainless steel tips are lead-free.



PK 5
Plastic cassette
for 5 D-refills



PP 20
Plastic cassette
for 20 D-refills



PB 10
10-pcs. plastic bag



PB 1/10
10-pcs. tear-off plastic strip



Individual tube for **liquid ink refills** (128 mm)
Individual tube for **large capacity refills** (102 mm)
Individual tube for **Capless refill P 8126** (110 mm)

Norms and Regulations

All our refills are in accordance with **ISO 12757-1** i. e. **ISO 14145-1**. The standard colours of the ballpoint pen ink in refills are in accordance with **ISO 12757-2** and thereby document-proof.

Thus all refills are resistant against water, acid, alkaline solutions, bleach and light and therefore suitable for use in public offices and authorities.

The ball pen inks and the inks of the refills made by **SCHMIDT Technology** are in accordance with EN 71-3.

All raw materials used for our refills and inks are pre-registered or already registered in accordance with REACH Regulation (EC) No. 1907/2006. All products have a much lower concentration of SVHC substances than the required 0.1 % or are even SVHC-free.

Accordingly, our products are plasticizer-free. Furthermore the European Regulation (EC) No 1272/2013 regarding polycyclic aromatic hydrocarbons can be confirmed.

In case you wish to export the refills to the USA, we can issue certificates regarding the TSCA and the California Proposition 65.

Further regulations on demand.

Due to the high quality requirements of our customers we manufacture all our products exclusively in Germany at our premises in St. Georgen. Most of the ball pen inks and inks are produced by **SCHMIDT Technology** itself or additionally bought from German manufacturers.

"Made in Germany" is our basis.

SCHMIDT® Writing Media

Regarding the development of inks and ball pen inks you can rely on the development competence and the know-how of **SCHMIDT Technology**.

Decades of experience in the development and production of the most diverse writing media are the basis for new products which comply with all current legal requirements in Europe. We are producing exclusively in Germany.

These writing media are only used in the products that are manufactured by **SCHMIDT Technology**.

We can develop almost each customer-specific colour for you upon submission of technical specifications and a given economic efficiency. The required tests are made in our chemical laboratory using the most modern test equipment. We will not supply these products to you until they have been tested intensively and until they meet our own high standards of quality.

It is our challenge to meet your requirements.

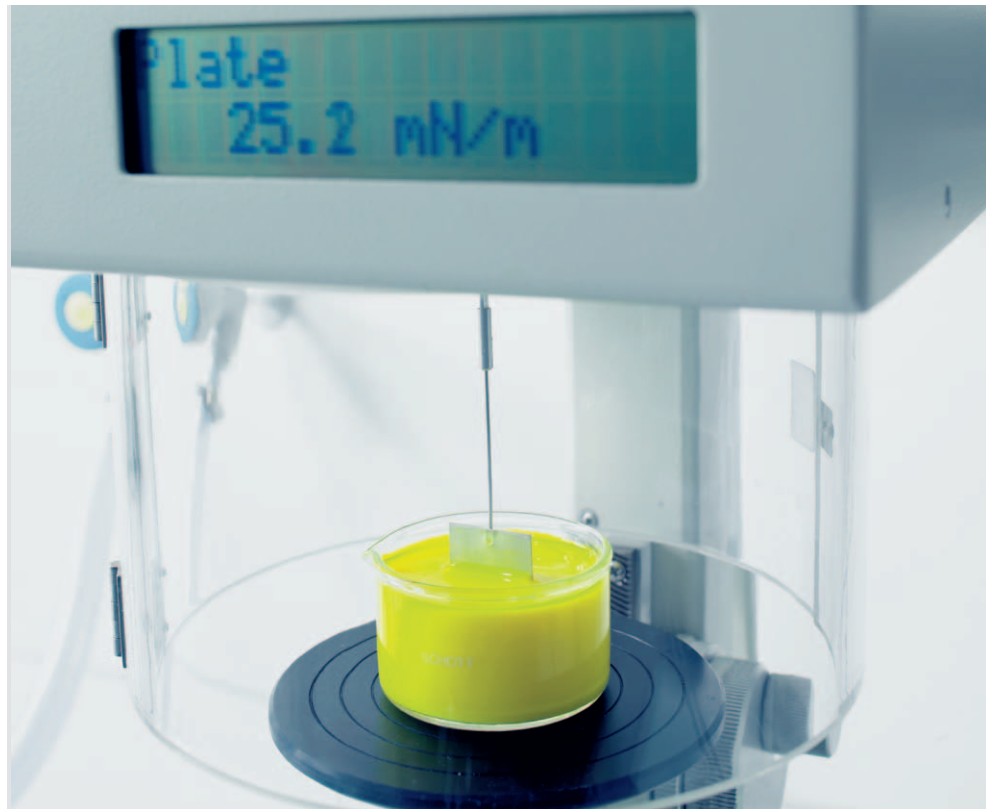

SCHMIDT® Dosage System Technique

We develop and manufacture customer-specific dosage systems for the most diverse applications of fluid media. The basis for successful products is our comprehensive know-how in product development, implementation in production toolings and assembly devices, as well as in application-supporting-chemicals. The implemented materials are precisely adapted to match the requirements of the various media.

Another point is the topic "Time to Market". Our own tooling, devices and mechanical engineering allow short project stages from the product idea to the finished product.

The necessary application test procedures are coordinated directly with the customer.

Here the following facilities are available:

- Application supporting chemical laboratory
- Facilities for climatic and environmental tests
- Facilities for physical tests



We are having long-time and practical experience for the implementation of the following media:

- Solvents or water-based media
 - Adhesives
 - Correction Fluids
 - Mineral and synthetical oils
- other media on request

We use the following sophisticated applicators:

- Springloaded extruded tips
- Ball tips
- Fibre wicks
- Brushes